

SURGERY FOR VICTIMS OF WAR

D. DUFOUR
S. KROMANN JENSEN
M. OWEN-SMITH
J. SALMELA
G.F. STENING
B. ZETTERSTRÖM



ICRC

**SURGERY
FOR VICTIMS
OF WAR**

SURGERY FOR VICTIMS OF WAR

D. DUFOUR
S. KROMANN JENSEN
M. OWEN-SMITH
J. SALMELA
G.F. STENING
B. ZETTERSTRÖM

Third edition
revised and edited by
Å. MOLDE



ICRC

International Committee of the Red Cross
19 Avenue de la Paix, 1202 Geneva, Switzerland
T +41 22 734 60 01 F +41 22 733 20 57
E-mail: icrc.gva@icrc.org www.icrc.org

Original: English

AUTHORS

Bernard Betrancourt, Physiotherapist, Switzerland
Daniel Dufour, M.D., Switzerland
Soeren Kromann Jensen, M.D., Denmark
Ora Friberg, M.D., Finland
Antero Lounavaara, M.D., Finland
Michael Owen-Smith, FRCS, United Kingdom
Jorma Salmela, M.D., Finland
Erkki Silvonen, M.D., Finland
G. Frank Stening, FRACS, Australia
B. Zetterström, M.D., Sweden

First edition edited by DANIEL DUFOUR
 Michael Owen-Smith
 G. Frank Stening

Second edition edited by ROBIN GRAY, FRCS,
 ICRC surgical coordinator, Geneva

Third edition revised ÅSA MOLDE, M.D.,
and edited by ICRC surgical coordinator, Geneva

Illustrated by PENELOPE L. ZYLSTRA, S.R.N.,
 Australia

ISBN 2-88145-010-5

© International Committee of the Red Cross
Geneva, September 1988, September 1990 (second edition)
and October 1998 (third edition)

PREFACE

The International Committee of the Red Cross (ICRC) is an impartial, neutral and independent organization whose exclusively humanitarian mission is to protect the lives and the dignity of victims of war and internal violence and to provide them with assistance.

The ICRC assists the wounded when war prevents society from providing them with the health care they need. It may furnish existing health facilities with medicines, equipment or staff, or set up independent ICRC hospitals. It may also help evacuate the wounded or treat them in first-aid posts. It provides training of all kinds to the medical staff involved, either on the spot or by organizing or participating in courses, seminars and conferences around the world.

Since the early 1970s, the ICRC has sent many civilian surgeons to war-torn countries. Most of them have no previous experience of war surgery, yet they are called upon in the course of their mission to treat all types of war-related injuries to different parts of the body. Moreover, given the early subspecialization of modern medical training, few surgeons have hands-on experience of head or maxillo-facial injuries, chest or abdominal wounds, or the different kinds of fractures.

This book is intended for surgeons who have volunteered to work with war wounded or who might suddenly find themselves in a situation where they have to deal with war wounded. It was written by surgeons with firsthand experience of war surgery. This third edition takes into account the comments made by the many surgeons who have used the manual over the years. It is dedicated to all the surgeons working in conflict areas to alleviate the suffering of the wounded.

Dr. Pierre Perrin
Chief Medical Officer

ACKNOWLEDGEMENTS to the 1st edition

The ICRC thanks the editors and all the authors of this manual on war surgery, particularly Mr. Frank Stening who wrote the first draft for it in 1982.

The wide experience in war surgery brought by all the contributors made it possible to define and establish the major aspects of the treatment of war wounded. Without the time and energy they gave on a voluntary basis the book would never have materialized.

Thanks are especially due to Mr. Soeren Kromann Jensen for all the work he did in planning the illustrations, which were completed by Ms. Penelope Zylstra, to Ms. Irène Deslarzes for her great patience and persistence in typing the text, and to Ms. Elisabeth Nyffenegger for her diplomacy and efficiency in organizing the two meetings in Geneva and enabling the authors to maintain regular contact with each other.

Appreciation must go to all the surgeons, anaesthetists, nurses, physiotherapists and nursing aides, whether from the ICRC and the National Societies or locally recruited, without whose dedicated work this manual would not have been possible.

ACKNOWLEDGEMENTS to the 3rd edition

This 3rd edition was brought out in response to the demands of many surgeons around the world. It is not just a reprint of the 2nd edition, but a thoroughly revised version, the text having been modified to take into account current ICRC thinking on matters pertaining to war surgery. It was edited for language and lay-out by Ms Angela Haden. Many thanks goes to her, to Ms Jacqueline Kopp, who did the initial typing, and to the two previous editors, Dr Daniel Dufour and Dr Robin Gray, who gave their permission for me to work freely on this edition.

Å. M.

VII

LIST OF CONTENTS

	Page
1. INTRODUCTION	1
2. FIRST AID AT THE POINT OF WOUNDING OR FIRST AID POST	7
AIRWAY	7
BREATHING	8
Ventilation	8
Chest wounds	8
CIRCULATION	9
Heart	9
Bleeding	9
BASIC TREATMENT	10
DRESSINGS AND SPLINTS	10
EVACUATION	11
3. TRIAGE AND RECEPTION OF A LARGE NUMBER OF CASUALTIES	13
CASUALTY SORTING	13
SETTING PRIORITIES	15
EMERGENCY PLAN FOR MASS CASUALTIES	16
Triage area	16
Personnel	16
Equipment	17
HOW TO PERFORM TRIAGE	18
4. ASSESSMENT AND RESUSCITATION IN HOSPITAL	19
AIRWAY	19
BREATHING	22
SHOCK	22
FLUID REPLACEMENT	23

BLOOD	24
OBJECTIVE OF RESUSCITATION	25
5. WOUND CLASSIFICATION	27
SOME WOUND CHARACTERISTICS OF DIFFERENT WEAPONS	29
Bullets	29
Fragments	29
Mines	30
6. WOUND EXCISION	31
TECHNIQUE OF WOUND EXCISION	31
Skin and subcutaneous tissues	32
Fasciotomy	32
Haematoma	33
Muscle	33
Foreign bodies	34
Tendons, nerves, bones and arteries	34
PERFORATING LIMB WOUNDS	34
LIMITATION OF CLOSURE	35
DRESSINGS	35
ANTIBIOTICS	36
IMMOBILIZATION	36
TERMINOLOGY	36
7. DELAYED PRIMARY CLOSURE AND SKIN GRAFTS	39
DELAYED PRIMARY CLOSURE	39
Optimum timing	39
Dead space	40
Wound care	40
SKIN GRAFTS	40
<i>Choice of graft depth</i>	41
Partial thickness grafts	41
<i>Application of grafts</i>	45
<i>Graft take</i>	45
<i>Graft meshing</i>	45
<i>Dressing of grafts</i>	48
<i>Storage of split skin grafts</i>	48

<i>Graft care</i>	48
<i>Dressing of donor sites</i>	49
Full thickness grafts	50
<i>Donor sites</i>	50
<i>Technique</i>	50
8. INFECTION IN WAR WOUNDS	53
GENERAL CONSIDERATIONS	53
ANTIBIOTIC PROPHYLAXIS	54
TETANUS	55
<i>Prophylaxis</i>	55
<i>Treatment of established tetanus</i>	56
GAS GANGRENE	56
ANAEROBIC CELLULITIS	59
9. TREATMENT OF NEGLECTED AND MISMANAGED WOUNDS	61
SURGICAL EXCISION	61
CLOSURE	62
10. WOUNDS OF LIMBS	63
FIRST AID	63
MANAGEMENT IN ADMISSION AREA	63
INITIAL WOUND MANAGEMENT	64
TECHNIQUE OF DECOMPRESSION	64
METHODS OF IMMOBILIZATION	66
Plaster splinting	67
<i>Principles of cast application</i>	67
<i>Tools and equipment</i>	68
<i>Techniques</i>	68
Traction	75
<i>Techniques</i>	75
<i>Postoperative check-up</i>	76
POSTOPERATIVE FOLLOW-UP	76
Wound	76
Definitive fracture holding	77
<i>External skeletal fixation</i>	77
JOINTS	79
HAND AND FOOT WOUNDS	80

First aid	80
Primary surgery and management	80
INJURIES OF PERIPHERAL NERVES	82
Primary surgery	82
Delayed primary suture	82
Postoperative care	82
VASCULAR INJURIES	83
Management of arterial injury	83
Postoperative care	87
AMPUTATIONS	87
General indications for amputations	88
Level of amputation	88
Procedure	89
11. CHEST INJURIES	91
HAEMOTHORAX	92
PNEUMOTHORAX	92
CHEST TUBES	93
Insertion of chest tubes	93
Postoperative controls	97
Removal of chest tubes	97
WOUND EXCISION	97
THORACOTOMY	97
OESOPHAGEAL INJURY	98
BRONCHIAL INJURY	98
CARDIAC INJURY	99
FLAIL CHEST	99
THORACIC EMPYEMA	100
THORACOABDOMINAL INJURY	100
INTERCOSTAL NERVE BLOCK	101
12. ABDOMINAL WAR WOUNDS	103
MANAGEMENT PRIORITY	104
GENERAL SURGERY PLAN	105
STOMACH	108
DUODENUM	109
SMALL BOWEL	110
COLON	111
RECTUM AND ANAL CANAL	114
COLOSTOMY CLOSURE	116

LIVER	116
SPLEEN	119
PANCREAS	119
GREAT VESSELS	121
PELVIC FRACTURES	121
POSTOPERATIVE CARE	121
Nutrition	121
Drains	122
Urinary catheter	122
Abdominal wounds	122
Physiotherapy	123
Painkillers	123
POSTOPERATIVE COMPLICATIONS	123
Fever	123
Abdominal dehiscence	123
Fistulas	124
Peritonitis	124
Postoperative intra-abdominal bleeding	124
13. URO-GENITAL LESIONS	125
KIDNEY	126
URETER	129
BLADDER	131
URETHRA	132
EXTERNAL GENITALIA	135
14. WOUNDS OF THE HEAD AND SPINAL CORD	137
WOUNDS OF THE HEAD	137
Emergency care	137
Clinical assessment	138
<i>Consciousness - Glasgow coma scale</i>	138
<i>Respiration</i>	138
<i>Blood pressure</i>	138
<i>Pulse</i>	139
<i>Temperature</i>	139
General physical assessment	139
Diagnostic tests	139
Surgical intervention	139
<i>Penetrating missile injuries</i>	139
<i>Depressed skull fractures</i>	140

<i>Closed intracranial haematoma</i>	140
Postoperative care	142
MAXILLO-FACIAL AND NECK WOUNDS	143
Emergency treatment	143
Soft tissue injuries	144
Facial fractures	145
<i>Mandible</i>	145
<i>Maxilla</i>	148
Neck wounds	149
SPINAL CORD INJURIES	150
<i>Paraplegia</i>	150
<i>Tetraplegia</i>	151
Pressure sores	152
<i>Surgery</i>	153
Bladder and urinary tract problems	154
Urinary infection	157
Equipment needed	158
15. WOUNDS AND INJURIES OF THE EYE	159
FIRST AID	159
EXAMINATION AND DIAGNOSIS	159
MANAGEMENT	161
Assessment of injury	162
Surgical procedures	163
<i>Minor injuries</i>	163
<i>Major injuries</i>	164
Burns	166
Treatment of complications	166
16. INJURIES OF THE EAR, NOSE AND THROAT	167
EAR	167
External ear	167
Middle ear	168
Inner ear	168
NOSE AND PARA-NASAL AIR SINUSES	169
Nose	169
Maxillary sinus	170
Frontal sinus	171
Ethmoidal labyrinth	171

PHARYNX	171
LARYNX	171
17. BURN INJURIES	173
FIRST AID	174
HOSPITAL CARE AND RESUSCITATION	174
Initial replacement therapy	176
Monitoring resuscitation	179
CARE OF THE BURN WOUND	179
Initial wound management	180
Local care	181
EXCISION OF ESCHAR AND SKIN GRAFTING	183
Skin grafting	184
PHOSPHOROUS BURNS	184
NAPALM INJURIES	185
18. COLD INJURIES	187
PHYSIOLOGY OF THERMAL REGULATION ..	187
LOCAL COLD INJURIES	188
Non-freezing injury	188
Freezing injury	188
Symptoms and signs	188
First aid and transport	188
Treatment	189
19. RECONSTRUCTIVE SURGERY	191
SOFT TISSUE DEFECTS	191
Local flaps	192
Arterialized flaps	192
Musculo-cutaneous flaps	192
BONE PROBLEMS	193
Malunion	193
Non-union	193
Osteomyelitis	193
Treatment	194
<i>Exploration and excision</i>	194
<i>Bone grafting</i>	194
SKIN CONTRACTURES	194

PERIPHERAL NERVE INJURY	196
TENDON REPAIR	197
VASCULAR COMPLICATIONS	197
Arterio-venous fistulas	197
Pseudoaneurysms	198
20. ANAESTHESIA IN WAR SURGERY	199
PREOPERATIVE PREPARATIONS	199
ANAESTHESIA METHODS	199
Surface anaesthesia	200
Infiltration anaesthesia	200
Nerve block	200
Regional intravenous anaesthesia	200
Regional anaesthesia	200
Ketamine	200
General anaesthesia	201
FURTHER READING	203

1. INTRODUCTION

Surgery for victims of war is different from the type of surgery practised for civilian injuries. War wounds are always extremely contaminated, and missiles may cause massive destruction of soft tissues, bones and other structures.

The principles of surgery for war wounds have been known for decades but need to be relearned by each new generation of surgeons working in a war situation.

The aims of war surgery are to:

- save life;
- avoid infectious complications;
- save limbs;
- minimize residual disability.

This manual aims to provide the surgeons, anaesthetists and nursing staff working in a hospital in a war environment with basic information about the treatment of war wounds. It describes the types of operations that have proved successful, based on the experience of the ICRC and others in different countries and conflicts.

ORGANIZATION

The outcome of war surgery is influenced by:

- type of injury;
- general condition of the patient;
- first aid;
- time needed for transport to hospital;
- quality of treatment (surgery, post-operative care, rehabilitation);
- possibility of evacuation to a better equipped hospital with more experienced staff.

All the above factors are supposed to be taken into consideration by the military.

In some countries, the organization of care is so efficient that any soldier who is wounded can count on receiving almost the same treatment as that available at home in peacetime. In developing countries, however, the health care system might already have been weak before the conflict started and may almost be non-functioning because of the conflict. Water and electricity supplies can be unreliable, trained staff often leave the area, drugs and disposable equipment cannot be replaced, and buildings can be destroyed. But even with basic technology, war wounded can be treated with good results, if doctors and nursing staff have the necessary knowledge and motivation.

The first aid provided at the point of wounding, or at the safest place near the battlefield, and rapid evacuation are of vital importance, because mortality and morbidity increase with delay between wounding and treatment. The more effective the first aid and the quicker the evacuation to a hospital, the better will be the final results. If first aid is inadequate or unavailable and the evacuation chain is long, then the outcome will be decided by nature. Some patients who might have survived will die, and the surviving patients will have established infections and other complications which lower their subsequent chances of survival. This is, unhappily, often the case where the ICRC and others are working.

Unlike a military field hospital, an ICRC hospital is responsible for all levels of medical care. It acts as a first aid post, field hospital, base hospital and referral centre. Thus, primary surgery, secondary surgery and basic reconstructive surgery are all conducted in the same facilities. Usually, there are only one or two surgeons working in each hospital. They must be able to treat all kinds of injuries, from simple soft tissue wounds to penetrating abdominal injuries, head injuries and complicated fractures. Ideally, they should be experienced general surgeons but nowadays such surgeons are difficult to find. The aim of this book is to help those who have to deal with all these injuries without having the proper training and experience.

SURGICAL TREATMENT

Correct primary surgery of war wounds is the basis of success.

To be successful, surgeons should be willing to learn and should adapt their behaviour to different circumstances. The majority of wounds will be to the extremities, and the objective is to treat them so that they heal as quickly as possible without becoming infected. Treatment is not complete until the patient is rehabilitated and high quality physiotherapy is required to ensure early mobilization after surgery. In addition, orthopaedic workshops are needed to provide prostheses for amputees and other suitable devices for the disabled, such as orthoses, crutches or wheelchairs.

Basic principles of management of war wounds:

- complete wound excision;
- delayed primary closure;
- antibiotics;
- antitetanus vaccine (+ immunoglobulin);
- no internal bone fixation.

Early and thorough wound excision:

- greatly reduces chances of death from gas gangrene or generalized infection;
- reduces the number of operations required to remove remaining infected or dead soft tissue and bone;
- allows delayed primary closure to be successful.

Correct surgery gives the patient the best chance of survival with a good quality of life and shortens the stay in hospital.

EQUIPMENT

In poor countries, the level of technology is usually low before the war. In other countries, the level may go down because of the war, with disrupted communication lines, unavailability of spare parts, and lack of knowledge about repair and maintenance. Nevertheless, ICRC experience shows that it is possible to perform good quality surgery with basic technology, such as simple X-ray, but without equipment for electric monitoring in the operating theatre and the postoperative ward.

Many organizations have developed standard lists of equipment and drugs, based on experience of working under difficult condi-

tions. These lists should take into consideration: the level of care to be provided, the standard treatment regime in the country, the directives from the local ministry of health, the level of care provided to patients in local hospitals, and the local level of resistance to drugs. Such standardization should avoid two main problems: first, the introduction of new drugs or equipment which are not available in the country and which may create new needs; and, second, the provision of surgical care which is of a higher standard and more sophisticated than that available in the host country.

STAFF

Because of the war situation, some of the staff may have left the hospital. Skilled staff are difficult to replace, and their absence will of course affect daily work in the hospital.

When working in a foreign country, it is essential to have the services of reliable interpreters to facilitate communication with staff and patients, as well as local authorities.

ENVIRONMENTAL CONSTRAINTS

Security is a major concern, and must be ensured for patients and staff by selecting suitable places for first aid posts and hospitals. Health facilities should be clearly marked with the protective emblem of the Red Cross or Red Crescent.

In a war situation, with few doctors and staff, and with wounded pouring in, hospital facilities may be overwhelmed. Stocks may run out, with the result that optimal treatment cannot be given. It is important to realize that surgeons also get tired and sick, and are sometimes scared. They therefore may not perform as well as usual. Cultural constraints may add to the frustrations, stopping surgeons from doing what they know is best for the patient. In many countries, amputations and laparotomies can only be performed with the consent of the family of the patient. It is hard to see young people die because necessary surgery cannot be performed.

Adaptation to the cultural, social and geographic context is essential.

Blood for transfusion is often difficult to obtain because of the religious or cultural restrictions in many countries. With the steady increase in HIV, testing must be adequate and indications for transfusion strictly limited. In some areas of the world, giving blood should probably be totally avoided. The use of blood should be restricted to vital needs and to patients with a good chance of survival. Anaemia resulting from parasitic infestations has sometimes to be accepted and should be treated with iron, folic acid and adequate food.

In a war situation most health structures will be dealing with war wounded. The wounded may, however, suffer from other diseases, such as tuberculosis, malaria, typhoid and intestinal worms, as well as malnutrition. The surgeon must therefore try to acquire some basic knowledge about the diseases specific to the area and their treatment. Local health care workers are usually familiar with these conditions and can be of great help.

PERSONAL QUALITIES

Three qualities are particularly needed by personnel working in ICRC hospitals:

- professionalism;
- sound judgement;
- adaptability.

This manual aims to enhance knowledge of how to maintain life, reduce suffering and give the best chance of improvement in the quality of life for the victims of war.

2. FIRST AID AT THE POINT OF WOUNDING OR FIRST AID POST

The essentials of first aid are to prevent death and to avoid further injury. Most deaths resulting from injuries from bullets and explosions are caused by loss of cardio-respiratory function and from haemorrhage. If these two problems can be controlled at the point of wounding, there is an excellent chance that the patient will survive evacuation to a hospital where surgical care can be provided.

The most important elements of first aid to consider are:

- **Airway;**
- **Breathing;**
- **Circulation.**

AIRWAY

Respiratory obstruction is an emergency that requires an immediate response. Speed in relieving respiratory obstruction is of the utmost importance. Maintaining an adequate flow of air to the lungs is essential.

Respiratory obstruction can result from:

- Aspiration of blood, foreign bodies or vomitus.
- Obstruction by the tongue. This can usually be controlled by extending the neck and placing the patient in the semi-prone position. An oropharyngeal airway will maintain an adequate airway under these circumstances.

- Laryngeal obstruction by a foreign body, such as loose teeth or pieces of dentures, food and blood clot. The obstructing foreign bodies can usually be removed manually.
- Oedema of the pharynx or larynx caused by inhalation burns. In this case, an endotracheal tube will be necessary.

BREATHING

Ventilation

When breathing stops as a result of primary injury, it is vital to restore ventilation immediately. Artificial respiration should be continued until normal breathing returns, but at a first aid post it is not possible to continue this treatment for more than a maximum of twenty minutes.

The simplest methods for use as first aid are the mouth to mouth method and the mouth to nose method. A third option is mouth to mouth, using a specially designed oropharyngeal airway with a mouthpiece for use by the rescuer. An Ambu bag should be used if available.

Chest wounds

Penetrating chest wounds may have a serious effect on respiration if the lungs are damaged. The heart and mediastinal structures may also be damaged. They always create a *pneumothorax*, which may be small or large but generally closed, and mostly there is some degree of *haemothorax*.

A penetrating wound of the chest may create a wound which remains open. This causes an open pneumothorax, in which air passing in and out of the pleural cavity, and bubbling through the blood coming from the wound, creates a characteristic sucking or blowing noise. Such a wound, commonly known as a “sucking wound of the chest”, may cause grave physiological changes resulting in rapid death unless treatment is given quickly.

The first aid treatment is to seal the wound in order to minimize the physiological changes and to allow the remaining undamaged lung to function better.

Open sucking wounds of the chest should be sealed with an airtight dressing.

The dressing can be improvised. It can be made from a wet bulky dressing that is securely fixed in place. If vaseline gauze is available, a more effective seal can be made using vaseline gauze next to the wound covered with a further dressing.

A *tension pneumothorax* occasionally results from penetrating chest wounds or from explosive blast injury. It more commonly occurs when a sucking chest wound has been sealed by an occlusive dressing, and this should be anticipated. Tension pneumothorax is an acute emergency and any large bore needle, inserted in the second intercostal space in the mid-clavicular line, will relieve it. In these circumstances, a flutter valve can be improvised using the finger of a rubber glove (see chapter 11).

A *flail segment of chest* may well result from closed injuries, when the number of ribs broken results in an unstable segment of chest wall and consequent paradoxical respiration. The physiological problems come from the bruised poorly functioning lung, rather than the paradoxical movement. They can, however, be minimized by firm Elastoplast strapping of the affected segment of chest wall and by careful *positioning* of the patient so that the damaged segment is against the ground, bed or stretcher.

Transportation of all patients with chest injuries should be with the uninjured side uppermost to allow optimal ventilation of the good lung.

CIRCULATION

Heart

If the heart has stopped as an indirect result of the injury, external cardiac compression must be initiated. This will often have to be carried out in conjunction with artificial respiration. It is usually not possible to combine the two procedures in a first aid post.

Bleeding

A dressing or any available material can be packed closely and carefully into a wound, and this will usually stop bleeding. If a blood vessel can be seen in the depths of the wound, and it is con-

tinuing to bleed, direct control may be obtained manually or with artery forceps, if available. *Blind clamping must never be attempted.* Pressure applied to pressure points over an artery may be of use in reducing haemorrhage until control can be obtained. Elevation of the wounded part will reduce venous bleeding.

A *tourniquet* is rarely required: it can save life but it also endangers a limb, unless it is correctly applied, released at regular hourly intervals for several minutes, and removed when facilities are available for adequate control of the bleeding. In general, a tourniquet should only be applied *as a last resort*, accepting the concomitant risks.

External haemorrhage can usually be controlled by direct pressure.

Internal haemorrhage from a penetrating wound cannot be controlled without surgery, and these patients therefore have a top priority for evacuation.

BASIC TREATMENT

Penicillin 5 mega-units 6-hourly should be started as soon as possible.

I.v. fluids (Ringer Lactate or Hartmann's solution) should be started for patients with major wounds and significant blood loss. Antitetanus toxoid vaccine should be given if available.

Analgesics can be given i.v., i.m., as suppositories or orally.

DRESSINGS AND SPLINTS

Wounds should be covered by clean dressings to avoid further soiling.

Fractures should be stabilized to avoid further damage to surrounding tissue, bleeding and pain.

The majority of fractures do not need complicated splinting when evacuation is going to be rapid. The upper limbs may be splinted in a sling or by using the patient's clothing. The leg may be splinted effectively by binding it, using any available material,

to the good leg. If there is any delay in evacuation, or the duration of such evacuation is prolonged, it is of the utmost importance to immobilize compound fractures of the femur and fractures around the knee joint. A good method of immobilization is by use of a Thomas splint.

EVACUATION

With all forms of trauma, including penetrating wounds, the patient's condition should be stabilized before evacuation. Skilled first aid at the site of injury should allow stability to be achieved in the majority of cases.

The major cause of exsanguination and death is likely to be a penetrating wound of the abdomen or central chest, in which access to control haemorrhage is not possible.

Delay in evacuation will contribute to an increase in mortality. This remains a major problem in the care of war wounded.

3. TRIAGE AND RECEPTION OF LARGE NUMBERS OF CASUALTIES

CASUALTY SORTING

The experience of two World Wars has demonstrated the importance of sorting casualties. The French term *triage*, which means to sort into groups according to quality, has been applied to the sorting of battle casualties since that time. It is the process of categorizing patients according to the degree of severity of injury, so that priorities can be established in order to use the available facilities most efficiently for the evacuation and care of the wounded.

When a large number of casualties are received, and when facilities and resources are limited, the setting of priorities may require very difficult decisions to be taken. Patients with very severe wounds which are heavily resource consuming, and who have little chance of survival despite treatment, may have to wait or may only receive minimal care in the interests of being able to intervene effectively for other victims.

The aim in a mass casualty situation is to do the best for the most.

The concept of triage has been extended to civilian disaster situations with considerable benefit and its use is now generally accepted worldwide.

Triage can take place anywhere along the line of evacuation of the casualty, from the point of wounding to the hospital where definitive treatment is to take place.

The *aim* of triage is to categorize the wounded on the basis of:

- the severity of injury,
- the need for treatment,
- the possibility of good quality survival.

The factors which affect the triage process are:

- the number and nature of the wounded,
- their condition,
- the facilities and personnel available to treat them,
- the lines of evacuation and the duration of transportation.

Effective triage at the site of the disaster leads to orderly evacuation of the wounded, the most efficient use of stretchers, ambulances or other transport, and the optimal use of medical and surgical personnel available. With the necessary training, rapid assessment of casualties can be carried out not only by doctors, but also by nurses, paramedical staff and first aid workers. *It should be possible to implement triage at any point along the line of evacuation.*

No task in the medical services requires greater understanding, skill and judgement than the sorting of casualties and the establishment of priorities.

If a number of seriously injured casualties arrive within a short space of time, triage should be done by the most experienced person willing and able to take on the responsibility. Based on sound clinical judgement, this person will decide:

- which patients need immediate resuscitation;
- which patients require resuscitation and immediate surgery as part of the resuscitation process;
- which patients have such small wounds that they can be managed by self-help or simple treatment and dressings – these patients should be rapidly segregated from other groups, kept out of the hospital and not allowed to interfere with the management of the more severely wounded;

- which patients have *such severe wounds that death is inevitable* under the circumstances (for example, severe head or spinal injuries, severe multiple injuries, and burns of more than 60%) – these patients and the dead should be removed from the triage area;
- and which patients will tolerate some delay before receiving surgical attention.

SETTING PRIORITIES

The categorization of patients into priority groups should be simple, as in the scheme below.

Category I – serious wounds – resuscitation and immediate surgery

Those patients for whom urgent surgery is required and for whom there is a good chance of recovery. In practice many of these patients will have abdominal or thoracic injuries or wounds of peripheral blood vessels.

Category II – second priority wounds – can wait for surgery

Those patients who require surgery but not on an urgent basis. In practice this applies to the majority of casualties: most compound fractures and penetrating head injuries for example.

Category III – superficial wounds – ambulatory management

Those patients who do not require hospitalisation and/or surgery because their wounds are so minor that they can be managed on an ambulatory basis. In practice this includes superficial wounds managed under local anaesthesia in the emergency room.

Category IV – severe wounds – supportive treatment

Those patients who are so severely injured that they are likely to die or have a very poor quality of survival. These include the moribund, or, patients with multiple major wounds whose management could be considered wasteful of scarce resources including operative time and blood.

The number of casualties who require urgent or early treatment may exceed the surgical capacity available. Usually the hardest part of triage is having to accept that patients might only receive analgesics, and if possible be removed to a quiet place where they can die in comfort and with dignity.

Triage decisions must be respected.

Staff members, relatives and commanders might try to influence the triage decisions, but these decisions should be made on purely medical grounds. Discussions should wait until after the emergency phase is over.

EMERGENCY PLAN FOR MASS CASUALTIES

The sudden arrival of large numbers of casualties may occur at any time. Prior planning prevents poor performance. Unless a plan exists for the reception and triage of mass casualties, chaos will result.

Security must be ensured by having guards at the gate of the hospital. Only wounded persons, possibly accompanied by a close relative, should be allowed to enter. All weapons must be left outside the gate.

Triage area

A *large space* should be prepared for the immediate reception of casualties.

The area should be cleared of all in-patients, and be large enough to permit easy movement of casualties and medical personnel.

All necessary equipment should be prepared and located in or close to the triage area.

There should be a plan for the relocation of in-patients from the designated reception area, and the plan should be put into operation as soon as notice is given of the expected arrival of mass casualties.

There should also be a plan for the transfer of patients, after triage, to wards, X-ray department or operating theatre.

Personnel

Triage should be performed by an *experienced nurse or doctor* with a good understanding of the functioning and capacity of the hospital. He or she has full responsibility for categorizing the casualties, and should be supported by a team consisting of a nurse and an assistant.

The duty of the *head nurse* is to make plans for all staff, including the non-medical staff working in the kitchen and the laundry, covering their role in the triage situation. Nursing teams should be formed for the triage area, with responsibility for:

- (a) administration of penicillin and tetanus toxoid to all casualties;
- (b) taking blood for grouping and crossmatching, if indicated;
- (c) setting up intravenous lines, and giving analgesics and other medication as prescribed;
- (d) bladder catheter, if indicated;
- (e) transfer of categorized casualties into separate areas for immediate, delayed or minimal treatment;
- (f) arranging the orderly flow of casualties to the operating theatre or X-ray department, as directed. *The use of X-ray should be limited; it is seldom essential under these circumstances.*

Surgeons and theatre personnel should have prepared the operating theatre and be ready and waiting for the casualties.

Equipment

At least 100 sets of routine patient folders, *each with a unique number*, should be prepared and maintained in readiness for a major influx of casualties. Each folder should include an admission chart, a fluid balance chart, and laboratory and X-ray request forms. A body stamp or which injuries can be marked improves recording.

Containers of emergency equipment should be stocked in a clean and easily accessible place. The stocks should include:

- venepuncture equipment,
- i.v. therapy equipment,
- dressings, bandages, scissors,
- catheters,
- naso-gastric tubes,
- drugs which are likely to be needed.

The drugs will probably need to be stockpiled separately. Stocks should include the appropriate antibiotics and analgesics, as well as tetanus toxoid and anti-tetanus serum. Lines to hang infusions on should be prepared in advance. Stretchers and blankets should be stored in the triage area.

A reasonable stock should be maintained of items that will be required for the management of extra cases in the hospital. There should be adequate numbers of bed blocks for elevation of the foot

of the bed, supplies of i.v. bottle holders, and supplies of dressings, plaster of Paris, splints and traction apparatus.

HOW TO PERFORM TRIAGE

Each casualty should be appropriately identified and assigned a medical chart. Good records are essential and every effort must be made to record the important aspects of the wounds, the treatment and the patient's triage category.

Each patient must be checked and the whole body, including the back, must be examined.

The person performing the triage should not *treat* the patients. Initial treatment is started by the nursing team, and the patient should be transferred as quickly as possible out of the triage area to make room for new arrivals.

When all new cases have been checked and categorized, a further assessment can be done. This may result in putting the patient in another category.

It is important for the triage personnel to identify and mark the dead, so that time and effort are not wasted on them.

It may be necessary to transfer minimal care patients to other sites, even outside the surgical hospital. If this is done, care should be taken to identify patients for follow-up treatment and administration of medication, and to exert some control over their whereabouts. Patients can easily get lost.

Triage is a continuous process and there is a need for continuous reassessment.

Access to the triage area should be blocked off, and a guard posted to keep other patients and onlookers from mingling with new casualties. Large numbers of relatives, in particular, need to be strictly controlled, and provision for them should be made close to the hospital compound.

Early consideration should be given to the relief of staff following a major emergency. A clear shift system will need to be instituted.

After every triage situation, a general meeting with the staff involved should be held to discuss what went well and what went wrong, to be able to improve for the next triage.

4. ASSESSMENT AND RESUSCITATION IN HOSPITAL

The wounded arriving in hospital without any previous treatment should be given first aid as described in chapter 2. If first aid has already been given, more skilful resuscitation can be done in the hospital where greater expertise and better equipment are usually available. Efforts should again concentrate initially on life-saving treatment for asphyxia and shock.

The first priority in treatment must always be the airway and breathing.

AIRWAY

The airway must be cleared by removing debris and foreign bodies manually from the mouth and oropharynx: suction must be used as necessary. If the patient is unconscious, or if there are fractures of the facial skeleton or major lacerations, an oropharyngeal airway must be inserted and the neck extended to allow free passage of air. If control is still not obtained, an endotracheal tube must be passed and artificial ventilation on an Ambu bag commenced. Deeply unconscious patients can usually be intubated easily. Others may be restless, irritable, uncooperative and hypoxic. Intubation under these circumstances usually requires sedation. Diazepam (5-10 mg) given intravenously will allow rapid intubation without struggling and without compromising the patient's hypoxic condition.

Tracheostomy should be an elective procedure. *The only specific indication for emergency tracheostomy in missile wounds is direct laryngeal injury.*

In an emergency, cricothyroidotomy is the treatment of choice.

Cricothyroidotomy (Figure 1) is quick, safe and relatively bloodless. A vertical skin incision is made, extending through the cricothyroid membrane. The handle of the scalpel is inserted and turned horizontally to hold the membrane open until a small tracheostomy tube can be inserted.

Needle cricothyroidotomy is preferred in an emergency situation in a child under twelve. The technique is to use a large i.v. cannula (gauge 14) inserted into the trachea below the point of obstruction. This technique is effective for about 45 minutes. A more definitive airway is then required.

Cricothyroidotomy is preferred to tracheostomy, which can be a difficult procedure in emergency situations and can be associated with profuse haemorrhage.

FIGURE 1

Cricothyroidotomy

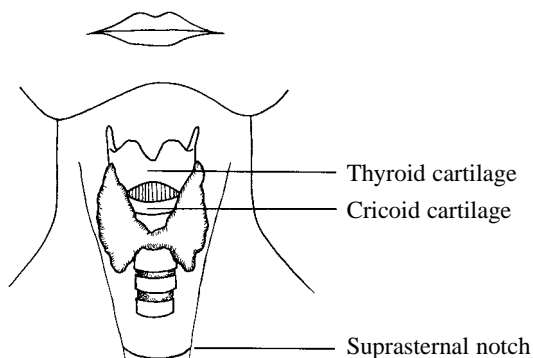

(a) *Surgical landmarks. The patient's neck should be placed in extension with a pad beneath the shoulders. First, the thyroid and cricoid cartilages are identified. The cricothyroid membrane is then identified as the depression in between.*

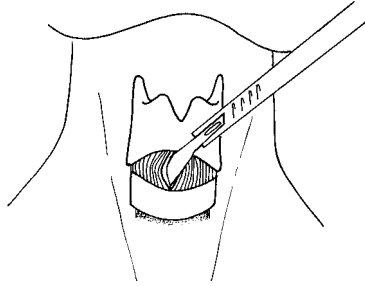

(b) A vertical skin incision is made over the cricothyroid membrane. The wound is spread apart using the thumb and index finger.

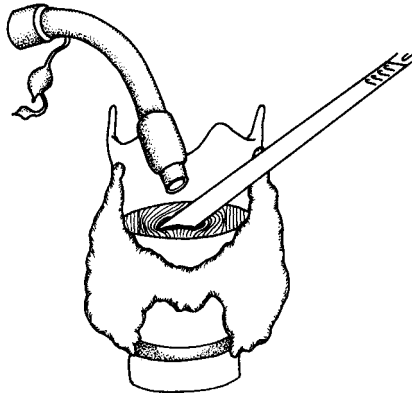

(c) The opening in the membrane is widened by insertion of the scalpel handle which is rotated through 90°.

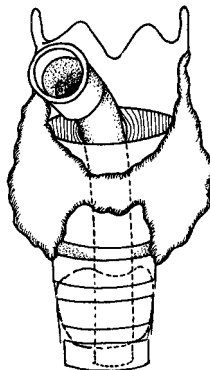

(d) A tracheostomy tube is placed through the opening and secured. The total procedure should take no more than 30 seconds.

BREATHING

The cause of respiratory distress must be found and treated. Clinical examination may reveal a sucking wound of the chest, pneumothorax, tension pneumothorax, haemothorax or a flail segment of the chest.

A *sucking wound* may be treated by the application of an airtight sealed dressing, best made with a piece of vaseline gauze or plastic sheeting covered with a bulky dressing, firmly taped into place. An intercostal drain may be required in such patients if they develop a tension pneumothorax. The patient should then be positioned with the *uninjured side uppermost*, thus allowing optimal ventilation of the undamaged lung.

An intercostal tube or widebore needle (see chapter 11) should be inserted into the second space anteriorly for a *pneumothorax* or *tension pneumothorax*, and a Heimlich one-way valve attached. The valve can later be replaced by an underwater seal.

A *haemothorax* should be drained using a widebore chest tube. This procedure can be life-saving and must be initiated on clinical grounds, rather than awaiting radiological confirmation of a large haemothorax.

A *flail chest* should be treated by bandaging and positioning of the patient as described in chapter 2.

In the rare instance of constrictive *haemopericardium* due to a penetrating missile wound of the heart, immediate pericardiocentesis, repeated if necessary, will be required until emergency thoracotomy is possible (see chapter 11).

SHOCK

In patients with missile wounds, shock usually comes from acute blood loss; neurogenic shock is surprisingly unimportant.

Severe bleeding can usually be stopped by packing the wound, provided the source is accessible. Any material can be used in an emergency, but it must be packed into the wound most carefully using small quantities first, followed by a more bulky dressing and finally a firm elastic bandage, to apply even pressure to effect haemostasis.

Finger pressure or direct application of artery forceps may occasionally be required. Once a wound has been packed and bleeding has been arrested, the dressing should not be removed until the

patient has been resuscitated and is in the operating theatre, with blood ready for transfusion if available. The surgical team should be ready to arrest bleeding by rapid intervention to obtain access to and control of the major blood vessels.

Beware of removing packs from missile wounds, as the resultant bleeding can be torrential and difficult to control.

Severe internal bleeding requires urgent operation as part of the resuscitation process. Such patients have a high priority for surgery.

FLUID REPLACEMENT

The shock-like state associated with trauma is most often hypovolaemic in nature. *The type of fluid for replacement is less important than the speed of getting the infusion running rapidly into the patient.*

A litre *immediately* is worth several litres in a few hours time.

It is good planning to have such initial intravenous fluid prepared, with drip sets and needles, for immediate insertion into the vein. In massive injury, with obviously gross blood loss, several widebore intravenous lines should be established and fluid pumped in rapidly to prevent the sequelae of exsanguination. Balanced electrolyte solution, such as Hartmann's or Ringer Lactate, is an excellent fluid to use for resuscitation in acute trauma.

Fluid replacement can begin with 2,000 ml of Hartmann's in 15-30 minutes, together with a plasma expander, either 500 ml of Dextran 70 (mol.wt. = 7,000) or one litre of Haemaccel or similar gelatine solution. *A urinary catheter is necessary to monitor the response clinically by observing urinary output.*

Not more than two litres of Haemaccel or one litre of Dextran 70 should be given in any 24-hour period.

Although volume replacement is vital in hypovolaemic shock, oxygen and small doses of i.v. analgesia are equally important.

BLOOD

Blood should be taken immediately for grouping and cross-matching.

It is unusual for a patient to require whole blood during the first ten minutes of resuscitation, but moribund exsanguinated patients may rapidly be given group O blood together with Hartmann's solution, as the threat of death outweighs the potential morbidity from transfusion reactions. Type-specific whole blood should be available in ten minutes, and crossmatched blood in 30-40 minutes.

When blood is used for major trauma cases, a micro-filter should be inserted into the drip set. The standard filter removes particles larger than 17 mm, whereas the micro-filter prevents the passage of particles larger than 10 mm. Although these filters do not significantly restrict the rate of transfusion, they should not be used when fresh blood and platelets are being given. Large quantities of blood and Hartmann's solution may be required. Ideally, every fourth pack of blood should be supplemented with one bottle of plasma, one ampoule of sodium bicarbonate (44.3 milli equivalents) and one ampoule of calcium chloride (10 g).

According to the capacity of the surgical facility, a maximum number of units of blood per intervention should be set. This is likely to be about 4 units, and this figure should only be exceeded if component therapy or fresh whole blood is available.

When giving blood:

- Use pressure infusion bags to facilitate rapid transfusion.
- If filters are not available, change the infusion set after every two or three packs of blood.
- If time permits, warm the blood to body temperature using locally-made water baths or the body heat of staff members.
- Dilute packed cell blood with isotonic saline to facilitate good blood flow.
- Give calcium chloride by separate i.v. route: one ampoule (10 g) for every four packs of blood.
- Give one ampoule of sodium bicarbonate (44.3 milli equivalents) for every four packs of blood.

OBJECTIVE OF RESUSCITATION

The aims of resuscitation are:

- to restore circulating blood volume and intracellular fluid;
- to restore normal blood flow and tissue perfusion;
- to attain a urinary output of 30-50 ml/h without overloading the lungs and adding to post-traumatic pulmonary insufficiency.

A rapid response to resuscitation allows surgery to be performed at the optimum time according to the priority for treatment. Failure to respond usually occurs as a result of internal bleeding: urgent operation to secure the bleeding source is part of the resuscitation process. *Once bleeding has been controlled, the fluid and blood replacement should improve the patient's condition.*

Successful treatment of major penetrating missile wounds depends on:

- rapid control of the airway;
- insertion of chest tubes;
- controlling haemorrhage by packing or operation;
- restoration of blood by early and rapid infusion of Hartmann's solution and blood.

5. WOUND CLASSIFICATION

Surgeons who treat war wounded often find it impossible to tell from examining the wound what kind of weapon caused the injury. The Red Cross wound classification is therefore based on the features of the wound itself and not on the weaponry or the presumed velocity of the missile.

Wounds are given a six-figure score according to the size of the entry and exit wounds of the skin, and whether there is a cavity, fracture, injury to a vital structure or any metallic body. The wound score is a useful clinical tool to communicate the severity of the wound to staff and colleagues without having to remove the dressings.

The wound scores can be used to evaluate quality of care, when combined with information on length of stay in hospital, number of operations performed per patient or units of blood used.

Parameters

E = entry in centimetres

X = exit in centimetres (X = 0 if no exit)

C = cavity

Can the cavity of the wound take two fingers before surgery?

C 0 = no

C 1 = yes

- F = fracture** **F 0** = No fracture
F 1 = Simple fracture, hole or insignificant comminution
F 2 = Clinically significant comminution
- V = vital structure** **V 0** = no
V N = (neurological) penetration of the dura of the brain or spinal cord
V T = (thorax or trachea) penetration of the pleura or of the trachea in the neck
V A = (abdomen) penetration of the peritoneum
V H = (haematological) injury of a major peripheral blood vessel down to Brachial a. or Popliteal a.
- M = metallic body** Are bullet or fragments visible on X-ray?
M 0 = no
M 1 = yes, one metallic body
M 2 = yes, multiple metallic bodies

FIGURE 1

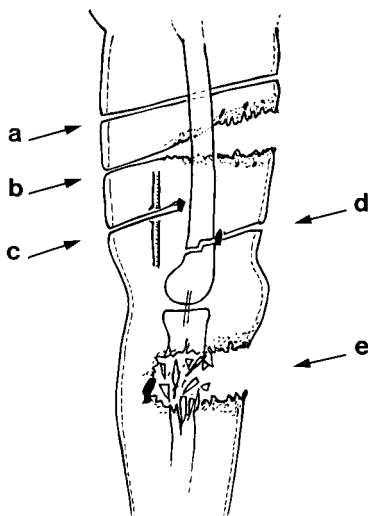

Examples of wounds: (a) simple track, (b) track produced by temporary cavitation, (c) simple track with involvement of a vital structure (artery), (d) low energy transfer wound with simple fracture, (e) high energy transfer wound with comminuted fracture.

Examples of wound scores associated with the wounds illustrated in Figure 1.

	E	X	C	F	V	M
WOUND (a)	1	1	0	0	0	0
WOUND (b)	1	4	1	0	0	0
WOUND (c)	1	0	0	0	H	1
WOUND (d)	1	0	0	1	0	1
WOUND (e)	6	0	1	2	0	1

SOME WOUND CHARACTERISTICS OF DIFFERENT WEAPONS

The wounding power of a missile depends on how much kinetic energy is given up when it strikes tissue. The energy is given by the formula $E = mv^2$ where m is the mass and v the velocity. This determines the extent of tissue damage.

Bullets

A typical bullet injury is wound (b) in Figure 1, with a small entrance wound and a large exit wound. The different patterns shown in Figure 1 depend on the energy deposit at the time of wounding. Fragmentation of the bullet will cause severe wounds, as in wound (e).

Fragments

Fragment injury may be caused by explosive devices, such as bombs, mortars, shells, rockets and grenades. The distance between the wounded person and the explosion determines the outcome.

The blast wave from an explosion might cause rupture of the ear drums and of gas-containing viscera, such as the stomach or bowels, as well as haemorrhagia in the lungs, without any penetrating wound.

Mines

Mines are exploding devices which, by their design, cause traumatic amputation of foot or leg, often combined with multiple severe wounds. The wounds are all severely contaminated by mud, grass, pieces of shoes and clothes driven deep into the wounds at the time of explosion. These injuries draw heavily on resources because they need a long operation time, many operations per patient, blood transfusions, dressing material, a long hospital stay, and a difficult period of rehabilitation, which usually includes the fitting of an artificial limb.

The wound classification is a useful tool to describe and document the characteristics of any wound from any weapon.

6. WOUND EXCISION

All wounds involve soft tissues, and most of them will be complicated by damage to other structures. *War wounds are often multiple.* Wounds in the buttock, thigh or perineum may enter the abdominal cavity; a chest wound may enter the abdomen.

The entire patient should be thoroughly examined, paying particular attention to the back and buttocks.

All clothing should be removed in so far as possible, bearing in mind local religious and cultural factors. Careful clinical examination will demonstrate the condition of the vascular supply to a limb, as well as the presence or absence of any nerve lesion.

Treatment of a soft tissue wound is a two-stage procedure:

- excision of the wound;
- delayed primary closure.

TECHNIQUE OF WOUND EXCISION

Wound excision is the process whereby dead and damaged tissue which is grossly contaminated with bacteria and debris from the surface is completely cut away. This leaves an area of healthy

tissue, with a good blood supply, capable of combating residual surface infection provided the wound is not sutured.

Clothing, dressing and splints are carefully removed and a sterile gauze pad is held over the wound. The skin over a large surrounding area and the whole circumference of the limb or body is cleansed with detergent, shaved, dried and then painted with an antiseptic. *In the case of multiple wounds, those on the posterior aspect of the body and limbs should be dealt with before those on the anterior aspect.*

Skin and subcutaneous tissues

Skin is very resistant to damage and is remarkably viable. It should be treated conservatively. Only skin that is grossly pulped should be excised. Usually no more than 1 mm of the skin edge need be removed. In order to gain access to the depths of the wound, the skin should be *incised* generously. In limbs, the incision should be made in the long axis, but not over subcutaneous bone, and at flexion creases it should deviate in the usual way. The subcutaneous fat has a poor blood supply and is liable to be heavily contaminated. This layer, and the shredded fascia about the wound, should be excised generously.

The commonest mistake is to make incisions too short.

Fasciotomy

The deep fascia must be incised along the length of the skin incision. This essential step allows wide and deep retraction, and exposes the depths of the wound. It may be necessary to add transverse cuts to the deep fascia to improve access. Deep to the fascia, the gloved finger is the best and most gentle probe, and can often be used to follow the track and to estimate the extent of the damage.

Fascial compartments may need decompression by fasciotomy to avoid muscle ischaemia.

The technique of fasciotomy is discussed in chapter 10.

The widely opened deep fascia, which has been freely incised, is left open to allow post-operative oedematous and congested tissue to swell without tension, so as to avoid interference with the blood supply.

Haematoma

The presence of a large haematoma generally implies that a major vessel has been damaged. Dislodging the haematoma can result in sudden heavy blood loss. It is wise to be prepared for vascular control before a haematoma is evacuated.

Muscle

All dead muscle must be excised.

Dead muscle is the ideal medium for the development of clostridial infection leading to gas gangrene. The track of the missile can be seen, and this track may be surrounded by dead muscle. It is absolutely vital that this dead muscle is excised.

All muscle which is not healthy and red, which does not contract when pinched or bleed when cut, must be excised until healthy, contractile, bleeding muscle is found.

The technique for this procedure is simply to pick up lumps of muscle with forceps, pinch them and, if they do not contract, excise them using scissors. These pieces should not be much larger than 2 cm². Cutting away lumps larger than this may result in the inadvertent removal of healthy tissue or vital structures.

Muscles will not contract if the patient is receiving a paralysing anaesthetic agent.

Bleeding should be controlled by pressure with gauze and by fine absorbable sutures. Cautery is best avoided, as it leaves dead tissue behind.

Bleeding should be controlled if the main artery is damaged. This should be assessed and dealt with as described below and in chapter 10. All nerves must be preserved. If they are found to be damaged, the site and degree of damage should be recorded.

Foreign bodies

The edges of the wound should be retracted and blood clot, dirt, debris and missile fragments removed from the sides and depths of the wound. Gentle and copious irrigation with saline must be used to wash out the residual debris and blood clot. Explore the wound with the finger to identify foreign bodies or unexpected extensions of the wound.

- DO NOT open fresh planes in healthy tissue.
- DO NOT explore unnecessarily for metallic fragments; they may be left in situ.
- It is absolutely vital to remove fragments of old clothing, indriven dirt and vegetation.

Tendons, nerves, bones and arteries

Tendons should be trimmed and only grossly destroyed fibres removed. Tiny fragments of bone with no attachment should be discarded, but any bone attached to periosteum or muscle should be retained.

- No attempt should be made at primary tendon, nerve or bone repair, as success is unlikely in these grossly contaminated wounds.
- An injury to a major artery to the limb must be either repaired or replaced by a saphenous vein graft immediately if a limb is to survive (see chapter 10).

PERFORATING LIMB WOUNDS

These must be dealt with by excising the wound on each side of the limb separately. Simple through and through wounds in which

there is minimal soft tissue damage do not require major surgical exploration. Where there is significant tissue damage or damage to major vessels, the wounds require exploration.

LIMITATION OF CLOSURE

Wounds should be left wide open, without any suture of skin or deep structures.

The only exceptions might be wounds in:

- *Face, neck, scalp and genitals.* These wounds may be closed primarily after wound excision.
- *Soft tissues of the chest wall.* These wounds must be excised, but healthy muscle must be closed over a sucking chest wound in order to make an airtight closure. The skin is left open.
- *Head.* The dura can rarely be closed directly, but closure should be effected if possible.
- *Hand.* These wounds should be left open for delayed primary closure (DPC). All viable tissue must be preserved as this simplifies reconstruction. Tendons and nerves must be covered by healthy tissue.
- *Joints.* Synovial membranes should be closed, but if this is not possible the capsule alone should be closed. Little harm seems to be done if the joint cannot be closed securely.
- *Blood vessels.* Those blood vessels that have been repaired primarily or by vein graft should, if possible, be covered by viable muscle.

DRESSINGS

Once the wound has been adequately excised, it should be covered with a bulky absorbent dressing made of dry fluffed-up gauze and held in place with a *loose* crepe bandage or non circumferential adhesive tape. The aim is to draw inflammatory fluid out of the wound and into the dressing.

Vaseline gauze should not be used, and the wound should not be “packed” in any way with the dressing since this will form a plug and prevent the free outflow of fluid.

The dressing should not be removed until taken down in the operating theatre at the time of DPC.

Wounds awaiting delayed primary closure (DPC) should not have dressings changed until formal closure.

The exception to this will be when *signs of persisting contamination and infection* develop. These signs include the development of toxicity in the patient, or a moist wound with an offensive smell. This indicates the need for further surgical excision, which should be attended to immediately. It should be remembered that all wounds awaiting DPC develop a bad smell after about 4 days, but the infected wound has a characteristic offensive odour and may produce a pussy discharge.

ANTIBIOTICS

Penicillin, 5 mega-units 6-hourly intravenously, should be given from the time of admission. When feasible, this should be substituted by oral penicillin, 500 mg 6-hourly for a total of 5 days treatment (see chapter 8).

IMMOBILIZATION

In all cases where there is an *extensive* soft tissue wound, even in the absence of a fracture, the entire limb should be immobilized. This can be achieved by plaster back slabs.

TERMINOLOGY

The English word excision means to cut off or cut out. Debridement is a French word meaning to lance, incise or unbridle. It is

also used in the sense of releasing. Debridement is used, perhaps incorrectly, in the English medical literature of war wound surgery to mean the removal of dead tissue. A further misunderstanding may be caused by the fact that excision, when used with reference to cancer surgery, tends to mean “excision en bloc” with a wide margin of surrounding tissue.

In this book the word excision is understood to mean the cutting away of dead, devitalized non-recoverable damaged tissue. The aim of excision is to remove all the tissue, debris and foreign material from the wound, which, if left, will delay healing and cause infection.

7. DELAYED PRIMARY CLOSURE AND SKIN GRAFTS

DELAYED PRIMARY CLOSURE

Delayed primary closure (DPC) is wound closure performed *within seven days of injury*. This is accomplished by simple approximation of the deep structures and skin, without tension.

No wound should be closed if there is persistent contamination or infection.

If there has been significant tissue loss, and simple approximation of the deep structures and skin cannot be performed, skin grafts, or skin or musculocutaneous flap will be required. These wounds cannot be managed by DPC.

If a wound has residual contamination or devitalized tissue when inspected for DPC, closure should be postponed and further surgical excision performed.

Adequate primary surgical excision is vital for uncomplicated wound closure by DPC.

Optimum timing

The aim of DPC is to close the wound during the fibroblastic phase of wound healing. This occurs between the 3rd and 6th days

following injury. Some wounds can be closed with safety earlier than others. For example, wounds of the face, neck and scrotum (3rd day) can be closed earlier than torso or upper extremity wounds (4-5th day) which in turn can be closed earlier than wounds of the lower extremities (5-7th day).

The timing of wound closure is important. Wounds must not be closed before they are clean. But wound closure by DPC is seldom possible 8 days following injury.

Dead space

As with all wounds, the obliteration of dead space is an accepted principle of DPC management. This may be technically difficult when there has been loss of deep tissue secondary to the injury of surgical excision. Absorbable sutures are used to approximate deep structures but undue tension should be avoided, as it will result in local tissue ischaemia which can impair local tissue resistance to the development of infection.

Drains should be avoided wherever possible in DPC. Drains act as retrograde conduits for skin contaminants to gain entrance into the wound, and they impair the resistance of tissue to infection.

Drains should never be used in wounds without dead space. In wounds with significant dead space, and where there is associated oozing into the wound, the use of a drain for *a few* hours but *no longer than 24* hours, may be a helpful adjunct to DPC management. If used, a drain should be placed dependently and, if possible, be of the suction catheter variety.

Avoid drains whenever possible in DPC. If used, remove within 24 hours.

Wound care

After DPC, the wound should be covered with some layers of dry gauze which can be left until the time of removal of sutures.

SKIN GRAFTS

If the wound cannot be closed by DPC because of skin loss, a skin graft can be used to close the wound, sometimes combined with partial DPC.

Free skin grafts may be *partial thickness* (epidermis and part of the dermis) or *full thickness* (epidermis and all dermis). Partial thickness grafts vary in thickness depending upon how much of the dermis is incorporated in the graft. The thicker the partial thickness graft, the less it will contract and the more it will resemble normal skin in colour and texture. But the risk of the graft failing is greater. Conversely, thinner grafts take more readily, but contract and distort more than thick grafts.

A skin graft can be used to cover any wound with enough vascularity to produce granulation tissue. This does not imply that granulation tissue should be present prior to grafting. Excessive granulation tissue should be scraped clear prior to graft application.

Tissues which will not support skin grafts include avascular areas, such as exposed bone without periosteum, exposed tendon without peritenon and hyaline cartilage. These cases will require some form of skin flap or musculocutaneous flap for closure.

Choice of graft depth

Thin partial thickness grafts are used when the quality of the recipient area is doubtful to support the graft, or when the development of a contracture is not important.

Thick partial thickness grafts are used when the recipient area is healthy with good vascularity, and over flexion creases where contractures should be avoided.

Full thickness grafts are used for the best cosmetic result in facial injuries, or to cover an area on a flexor surface with a good recipient area.

Partial thickness grafts

Split skin grafts (thin and thick partial thickness grafts) are taken from an area which can produce a broad area of skin. The common sites are the upper medial, posterior and lateral thigh, and the arm and forearm (Figure 1).

Split skin grafts should be taken using a dermatome. They can also be taken by either free hand knives or scalpels, if dermatomes (Figure 2) are not available.

When small areas of split skin are required a small *free hand knife*, such as a De Silva knife which incorporates a razor blade, can be used. Larger areas of skin are harvested using an instrument

FIGURE 2

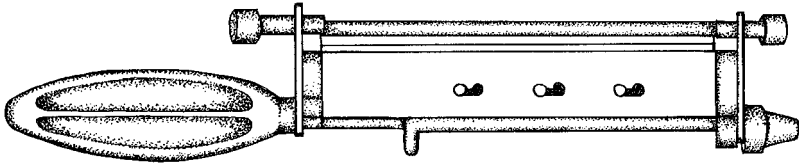

A dermatome. Different models, with disposable blades, are available. The thickness of the split skin graft harvested is controlled by the screw at the right end of the instrument. The setting is then locked using the screw at the left end.

The ungreased skin board is applied to the end of the donor site by an assistant who applies tension so as to keep the skin tight. The assistant's other hand can be applied underneath the donor site so as to flatten the area from which the graft is being taken (Figure 3).

FIGURE 3

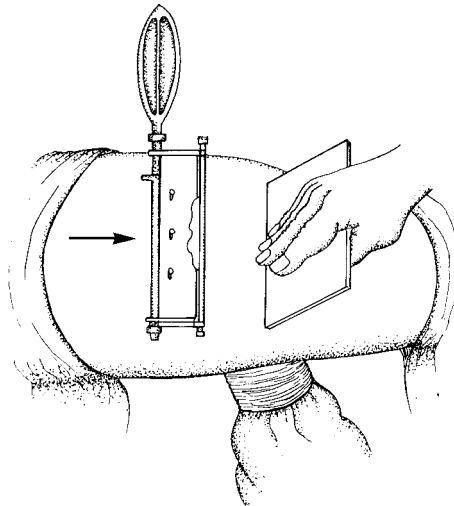

Harvesting a split skin graft from the medial side of the thigh. Note the assistant's hand flattening the donor site by exerting upward pressure on the undersurface of the thigh.

such as a Humby or Watson knife. The principles for the use of all hand knives are the same. The blades are disposable and are fitted into the knife. A calibration control is adjusted to set the depth of split skin required. Once this has been adjusted, a locking nut is tightened at the opposite end of the knife. It is important to check the gap between the blade and the knife before use, by holding the instrument to the light and visually checking the gap. The gap should be even throughout its length.

Visually check the gap between the knife and the blade before use.

The area of skin to be removed is rubbed with vaseline gauze. If the area is hairy, it should be shaved. The cutting edge of the knife and the edge of one skin board should also be greased.

FIGURE 1

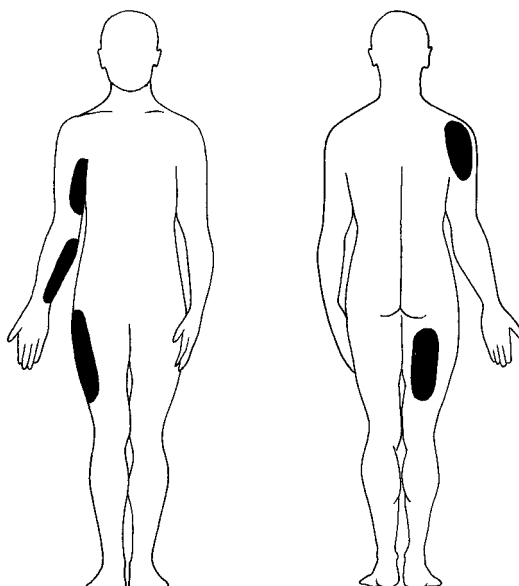

Donor sites for partial thickness grafts.

The greased board should be applied about 4-5 cm in front of the ungreased board, and counter traction should be applied so as to increase the skin tension. The knife should be applied to the skin at an angle of 30° and even side-to-side cutting movements of about 2 cm should be made. *Minimal effort should be made to advance the knife which will advance with the greased board.* Continuous movement of the knife is essential. When the desired amount of skin has been raised, the wrist is supinated and the knife will cut through the skin. The skin should be placed on a saline soaked gauze swab, undersurface away from the gauze, and stored until applied to the recipient area.

Reverdin grafts (pinch grafts) (Figure 4) can be used to cover large areas of defect and where the recipient areas are unfavourable, such as moving muscles in different planes. A full take is not expected. In these grafts the area between the grafts will coalesce as the graft spreads outwards. The cosmetic result is poor.

FIGURE 4

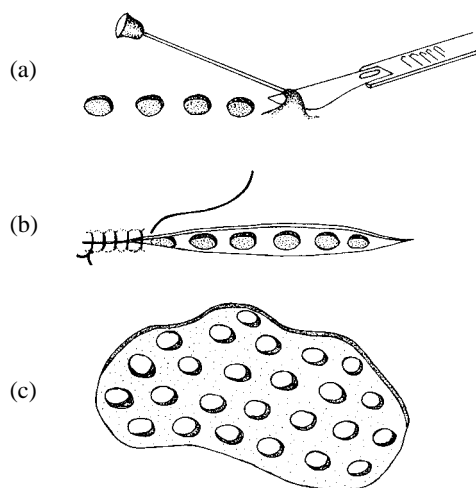

Reverdin (pinch) grafts:

- (a) Pinch grafts are taken by lifting the skin with a needle and cutting 1 cm diameter round patches of full thickness skin with a knife.
- (b) If the patches are taken in a line, the area can be excised and the wound closed by primary suture.
- (c) The patches are spread over the receptor site with gaps of a few millimetres between each piece.

The grafts are cut from the donor area using a scalpel blade and can vary in size up to about 2 cm² . To facilitate harvesting, intradermal saline can be injected into the donor area prior to cutting. This helps to avoid cutting the grafts too deeply. The harvested skin is handled as described previously until it is applied to the recipient area.

Application of grafts

Once the partial thickness graft has been cut to its required depth it is either (a) applied immediately if the recipient bed is clean and haemostasis is secure, or (b) applied after 24-48 hours if there is a persistent capillary ooze, or it is felt the quality of the recipient bed can be improved.

The graft is laid across the recipient bed and cut approximately so that it is slightly larger than the bed. This is important as it allows for graft contraction. Grafts tend to fold in on themselves, especially if they are thin, and *care must be taken to have the cut under-surface in complete contact with the recipient bed*. Often a graft is placed on a wound that is deeper than the thickness of the graft. In these cases the edge of the graft at the base of the wound must be carefully approximated to include the entire height of the defect.

Grafts applied immediately following harvesting are generally sutured in place. When this is done it can be helpful to place several anchor sutures about the circumference, which can be left long and used as tie-overs across the dressing to help keep the graft in place. A continuous fine (5-6/0) absorbable suture can be run around the edge of the graft to provide adequate edge contact. The excess skin of the graft can either be trimmed once the graft has been sutured, or left to be trimmed approximately 10-14 days later.

Delaying the application of grafts for 24-48 hours is an acceptable and often preferred method, especially if the recipient bed is moist.

If necessary, the harvested skin can be stored and applied up to three weeks later, without decreasing the graft success rate. Grafts applied in this fashion are mostly not sutured to the wound and they can be applied under sterile conditions in the ward with minimal discomfort to the patient.

Delayed application of split skin grafts is often a preferred method.

Graft take

There are three major factors determining the success rate of split skin grafts:

- (a) A vascular recipient bed which is *free of pathogenic bacteria*. Normal bacterial flora will not necessarily interfere with graft survival. But a small concentration of pathogens will usually result in failure. The most common pathogens causing graft failure are coagulase positive staphylococci and pseudomonas. Beta-haemolytic streptococci, even in small amounts, will result in graft dissolution.

Grafts should be harvested under sterile conditions and placed on a clean, vascular recipient bed.

- (b) *The vascularity of the graft itself*. Thin split skin grafts are more vascular on their undersurface than thick grafts. For this reason, a thin split graft has a higher chance of survival than a thick graft.
- (c) *The maintenance of contact between the graft and the recipient bed*. If the graft is under tension, if blood, serum or purulent material collects between the surfaces, or if there is movement of the graft on its bed, satisfactory contact cannot be maintained.

Adequate pressure must be applied to the graft when it is sutured or placed on its bed such that there is maximal contact between the two surfaces. It is, however, important to avoid excessive pressure as this will “strangle” the graft and prevent vascularization. Fluid should not collect beneath the graft. Meticulous haemostasis is therefore required before suturing the graft in situ. If there is any doubt, the application of the graft should be delayed. If a serous ooze is anticipated, *meshing of the graft* will provide a series of fenestrations which will allow drainage. Collections of serum, and sometimes clot, beneath the graft can be expressed within the first few days with some hope of graft survival.

Graft meshing

In cases where there is insufficient autograft to completely cover raw areas, such as large burns, graft meshing is useful (see Figure 5).

It can also provide for drainage of exudate and blood through the graft. Grafts are meshed by placing them on a surface, preferably a wooden board, undersurface facing upwards, and making numerous incisions through the graft with a No. 15 scalpel blade. The fenestrations can, with tension, be made as wide as required. *Optimally, the ratio of gaps to skin should be 3:1.* In this way, skin can be applied to cover an area three times its original size. Over a period of 10-14 days, the skin grows across the interstices and complete healing is obtained.

FIGURE 5

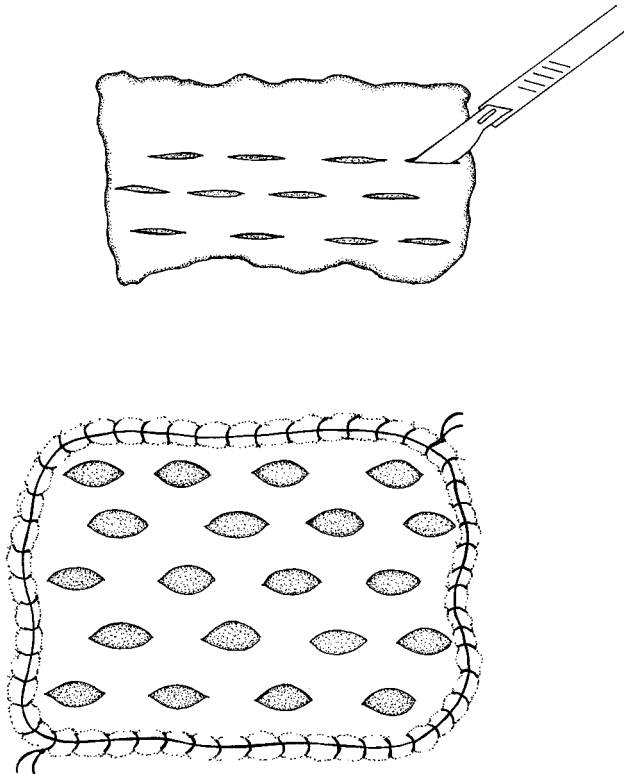

Meshing of a skin graft.

Dressing of grafts

Once the graft has been sutured or placed on the recipient bed, it should be covered with a sheet of vaseline gauze followed by small pieces of cotton wool or gauze soaked with saline. These pledgets should be pressed into the concavities of the defect to ensure that there is complete apposition between the graft and the bed. The dressing should then be either anchored in place by tie-over sutures, or covered with a thick layer of cotton wool held in place by a crepe bandage.

It is imperative that there is complete apposition between the graft and its bed.

Grafts can be left exposed without dressing and if necessary the area splinted and protected from bed clothes by a frame. This allows for regular inspections of the site and the expression of collections of serum or clot. This is particularly useful in cases where the recipient bed is of doubtful quality.

Storage of split skin grafts

It is always advisable, if possible, to take more than the required quantity of split skin when harvesting. The excess, and skin taken for delayed application, can be stored for up to three weeks in an ordinary domestic refrigerator at 4°. The skin is placed on a moist piece of gauze with the cut, or undersurface, away from the gauze. The grafts should be placed in sterile jars with or without normal saline. If saline is not included in the jar, the gauze must be kept moist. Jars should be stored with an airtight lid and *carefully labelled with the patient's identification and the date of harvesting.*

Graft care

Grafts must be cared for by experienced personnel. A graft may be saved if a seroma or haematoma is evacuated early. *It is also possible to lose a good graft by clumsy or careless removal of the dressing.*

Grafts require careful nursing care.

When a graft is inspected, the dressing should be carefully removed using two pairs of tissue forceps: one holding the graft and keeping it applied to its bed, the other removing the dressing.

- If a graft has been applied to a doubtful area, it should be inspected after 72 hours.
- If a graft has been applied to a good quality bed, it should be inspected after 5-10 days (according to the preference of the surgeon).
- If a haematoma or seroma is found, it should be expressed using firm controlled pressure. Another firm dressing of vaseline gauze should be applied. These grafts are then inspected on a daily basis until they have become firmly adherent to their base.

Any graft which is dead or floating on a “sea of pus” should be removed and the wound cleaned with saline dressings. If the wound is more than one centimetre square, and clean, it should be re-grafted.

Normally, all grafts should be covered initially with vaseline gauze and bandages, and need protection for at least ten days.

Following this period, they should be firmly adherent and can be left exposed. A daily inspection is then required.

Dressing of donor sites

Split thickness graft donor sites can bleed briskly, and in children can result in significant blood loss. Donor areas can be extremely painful, especially when dressings become firmly adherent. The following regimen minimizes discomfort:

- (a) Immediately apply a dressing, kept in place if necessary with an elastic bandage, and leave while the graft is being applied.
- (b) Remove the dressing, by which time haemostasis will have been achieved. If there is persistent bleeding, aluminium chloride or cauterization may need to be used.
- (c) Cover the donor site with a membrane dressing, such as Op-site. The dressing should be about twice the size of the donor bed, as occasionally there is fluid build-up beneath the membrane. If fluid does accumulate, it can be evacuated by pricking the membrane with a needle and expression. The perforation site can be covered with a smaller piece of membrane. If

the dressing falls off it can be reapplied. Generally, dressings stay in situ for the desired period of about ten days. They can then be removed.

- (d) If Op-site is not available, a firm pressure dressing of vaseline gauze, cotton wool and crepe bandage should be applied and kept from falling down the limb by adhesive strapping. The dressings should be left in place for 10-14 days.

Full thickness grafts

Full thickness free skin grafts consist of the epidermis and entire dermis. These grafts are used principally in the *head and neck*, but they can also be used on extremities to provide thicker cover.

The *advantages* of a full thickness graft include its better texture and colour. Full thickness grafts also allow for the transfer of hair-bearing skin, as all the dermal adnexal structures are intact. They contract less than split skin grafts. The main *disadvantage* is a lower survival rate. The recipient bed must be in optimal condition to take a full thickness graft. There should be meticulous suturing and approximation between the graft and the recipient edge. Generally, a full thickness graft is small because the donor area has to be primarily sutured. Occasionally, a larger area can be taken using a skin graft knife, but the donor area will then require a split skin graft for cover.

Donor sites

The donor sites will generally be above the clavicle, in front of and behind the ear. In older people, the cheek in the line of a skin crease may also be used. The donor site is primarily sutured following harvesting of the graft (see Figure 6).

Technique

The graft can be taken with the aid of local anaesthetic. The recipient area should be cleansed in a sterile fashion and a template made exactly to fit the defect. The template is to be placed on the donor site and an outline drawn around its circumference. The area should be injected with local anaesthetic with adrenaline 1:300-400,000 and left for five minutes before incision. The full thickness skin should then be excised exactly. The graft should be kept moist with saline impregnated gauze and left for no longer than

30 minutes at room temperature. If it is to be kept longer than 30 minutes before application, it should be kept refrigerated.

The graft must be thoroughly defatted before application. This is best achieved by placing the moist graft, epidermis-side down, on the finger tip and meticulously excising the fat using scissors.

FIGURE 6

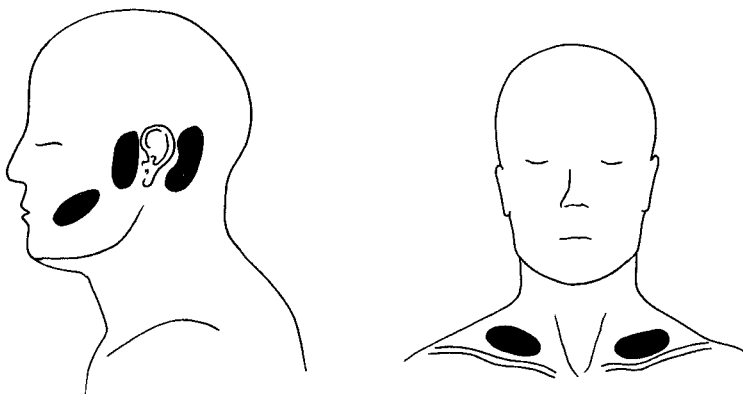

Donor sites for full thickness grafts.

The graft should be sutured in place meticulously. Six to eight interrupted nylon sutures should be inserted and left long for tie-overs. Small interrupted or continuous fine 5/0 sutures should be placed around the circumference. Once the graft has been sutured in position, a bolus of dressing should be made with vaseline gauze and moist cotton wool pledgets, and the tie-over sutures brought together. The dressing should be snug, but not so tight as to strangle the graft.

The dressing should be left in place for 7-10 days and then removed. At that time the graft may be any colour from pinkish or pinkish white to black. Even a graft that looks black when inspected can survive. No judgement about graft survival should be passed until a month from the time of application.

8. INFECTION IN WAR WOUNDS

GENERAL CONSIDERATIONS

All war wounds are grossly contaminated with bacteria and will inevitably become infected unless treated quickly and correctly. Ideally, these wounds should be treated surgically by excision of the wound within six hours. Up to that time the wound is simply contaminated, but delay allows invasive infection to become established and successful treatment becomes protracted.

The major bacterial contaminants in war wounds are:

- (a) Gram-positive pyogenic cocci, causing staphylococcal and streptococcal infection.
- (b) Gram-negative bacilli, including *Escherichia*, *Proteus*, *Klebsiella*, *Pseudomonas* and *Bacteroides*.
- (c) Gram-positive bacilli. The *Clostridia* species are strict anaerobes and are widely distributed in the environment. They are carried in the faeces. They can be demonstrated in about 30% of war wounds and are the cause of gas gangrene.

The major threat to a patient with a war wound is the development of gas gangrene.

The principles of war surgery are based on extensive experience and aim to avoid the major threat of gas gangrene.

ANTIBIOTIC PROPHYLAXIS

Penicillin is the drug of choice.

Clostridia are sensitive to penicillins, erythromycin and tetracyclines.

The doses recommended below are for adults

The best antibiotic is good surgery

I. Compound Fractures, Amputations, Major Soft Tissue Wounds

PNC-G 5 MIU IV x 4 for 48 hours, followed by PNC-V 2 tablets x 4 until Delayed Primary Closure (total five days). Continue PNC-V for five days if closure is performed with a split skin graft. If redebridement is performed instead of delayed primary closure: stop antibiotic unless there are signs of systemic infection or active local inflammation (fever, pain, oedema, heat, redness).

II. Antipersonnel Land Mine Injuries of Limbs whatever the delay, Compound Fractures or Major Soft Tissue Wounds with delay of more than 72 hours

PNC-G 5 MIU IV x 4 and Metronidazole 500 mg IV x 3 for 48 hours, followed by oral PNC-V 2 tab x 4 and Metronidazole 500 mg x 3 until Delayed Primary Closure.

III. Haemothorax

Ampicillin 1 gm IV x 4 for 48 hours, followed by Amoxycillin tab 500 mg x 4 to be continued until two days after removal of the chest tube.

IV. Penetrating Cranio-cerebral Wounds

PNC-G MIU IV x 4 and Chloramphenicol 1 gm IV x 3 for at least 72 hours, Continue IV or oral according to condition of the patient for a total of 10 days.

V. Abdominal Wounds

A: SOLID ORGANS ONLY; LIVER, SPLEEN, KIDNEY (and isolated bladder)
PNC-G 5 MIU IV x 4 for 3-5 days depending on drainage

B: STOMACH, SMALL INTESTINES

Ampicillin 1 gm IV x 4 and Metronidazole 500 mg IV x 3 for 3-5 days.

C: COLON, RECTUM, ANUS

Ampicillin 1 gm IV x 4 and Gentamycine 80 mg IV x 3 and Metronidazole 500 mg IV x 3 for 3-5 days.

(If IV Metronidazole or Gentamycine are not available give IV Chloramphenicol.)

Despite the great therapeutic use of antibiotics in infected wounds, *they are no substitute for adequate excision of dead tissue and general surgical principles*, such as faecal diversion and adequate wound excision and drainage.

TETANUS

Tetanus is always a risk with any penetrating wound. The risk is greater for severe wounds caused by penetrating missiles. Virtually total protection against the infection can be obtained by active immunization with a course of three tetanus toxoid injections at intervals of four weeks and six months.

Clostridium tetani is the causative organism and it is a strict anaerobe. The organism produces an extremely potent toxin called tetanospasmin which spreads by intra-axonal routes, or by blood-borne invasion. The toxin affects the nervous system at the motor end-plate by inhibiting the release of acetylcholine. There is, in addition, lower motor neurone dysfunction within the spinal cord and inhibition of motor activity in antagonistic muscles that cause unopposed reflex activity, giving rise to the typical spastic phenomena of tetanus. Selective binding of the toxin in the brain leads to the rigidity of the neck and trismus typical of the early signs of tetanus.

Prophylaxis

The best precaution against tetanus is early and adequate excision of dead tissue from wounds, and leaving wounds open.

Most patients in developing countries are not actively immunized and therefore the risk of tetanus in war wounds is great. Penicillin should be given to all patients, as for those with soft tissue wounds. Where there is a delay between wounding and surgical treatment of more than 24 hours, anti-tetanus human immunoglobulin prophylaxis (500 I.U.) should be given. All wounded should receive a first injection of tetanus toxoid vaccine.

Tetanus prophylaxis

All patients whatever their immunization status:

- (a) benzylpenicillin 5 million units i.v. 6-hourly;
- (b) thorough excision of the wound.

Immunized patients:

booster dose of tetanus toxoid 0.5 ml i.m.

Non-immunized patients:

- (a) anti-tetanus human immunoglobulin 500 I.U. i.m. (adults) or 250 I.U. (children under 15 years old) if more than 24 hours since injury;
- (b) tetanus toxoid 0.5 ml i.m.
- (c) tetanus toxoid 0.5 ml to be repeated at four weeks and again six months later.

Treatment of established tetanus

After the wound has been excised and penicillin given, the patient should if possible be nursed in an environment devoid of stimulation. Anti-tetanus serum, preferably anti-tetanus human immunoglobulin (3000 – 6000 I.U.i.m.), should be given as soon as possible. Spasms are to be controlled pharmacologically by intermittent doses of diazepam (2-20 mg i.v. hourly).

Clinical tetanus does not confer normal immunity. The patient therefore needs to be immunized after recovering from the disease.

GAS GANGRENE

Gas gangrene as a peculiar complication of wounds has been known since the time of Hippocrates. Its occurrence in all the wars of history, as well as from other traumatic causes, has been widely described, mainly because of its dramatic manifestations and very high associated mortality.

Gas gangrene is a rapidly spreading oedematous myonecrosis occurring characteristically in association with severe wounds of extensive muscle masses contaminated with pathogenic sporebearing anaerobes, particularly *Clostridium perfringens*. Almost every case presents a mixed bacterial flora and it is unusual for a single organism to be responsible for the infection. Clostridia are very widely distributed in nature, including in soil, and can be isolated from faeces in almost every case.

The features of the disease result, first, from the local action of the organisms on muscle sugar, producing acid and gas, and on muscle protein, causing digestion. Secondly, the organisms produce soluble, very potent toxins which diffuse into the tissues causing further tissue destruction and profound toxæmia. The breakdown products of the muscle from the effects of the toxin are very toxic in their own right. The combination of breakdown products and specific toxins causes the relentless and profound toxæmia which, if untreated, will inevitably lead to death.

In large muscle wounds there will always be areas of ischaemia and the potential for gas gangrene. But gas gangrene can also develop even when the trauma is not very severe. If the wound is deep, contains necrotic tissue and is *isolated from the surface*, it is possible for an anaerobic infection to become established. The presence of foreign bodies in wounds such as clothing, soil, metal or wood, the prolonged application of tourniquets or tight plasters, and fascial compartment compression syndromes will increase the risk of developing gas gangrene.

Delayed treatment is the main cause of gas gangrene in war wounds.

The incubation period of gas gangrene is usually short, almost always less than three days, and in the majority of cases less than 24 hours. Incubation periods of up to six weeks have occasionally occurred.

Typically, gas gangrene manifests itself with the sudden appearance of pain in the region of the wound. *The sudden onset of pain*, sometimes so sudden as to suggest a vascular catastrophe, *always suggests the possibility of gas gangrene in a wounded person*. Soon afterwards the limb becomes oedematous and is associated with drainage of thin serous or serosanguinous exudate which may

become gelatinous. The pulse rate rises markedly but the temperature is rarely more than 38°C. The patient clinically deteriorates and within several hours becomes anxious and frightened. The patient may be euphoric, and the face pale or livid, often with marked circumoral pallor. The patient is hypotensive and may vomit in severe cases.

Immediate surgical intervention is essential in case of gas gangrene.

The presence of gas is not obvious in the early stages, and may be completely absent. The skin is tense, white, often marbled with blue, and rather colder than normal. Rarely, slight bronzing may be seen around the taut edges of the wound. The pathological process advances rapidly.

Swelling, oedema and toxæmia increase, the serous discharge becomes more profuse and a peculiar sweetish smell may be present. *The smell is variable and not pathognomonic.* In untreated cases, local bronzing of the skin becomes more diffuse, greenish yellow areas occur in which blebs may form and become filled with dark red fluid, and patches of cutaneous gangrene may occur.

Gas is usually produced at this stage and is partly responsible for the swelling of the affected part. It is produced in and between the muscle fibres, and eventually escapes into the subcutaneous tissues under pressure through holes in the fascia. It then spreads rapidly beyond the confines of the infected area. The skin may, however, appear normal, even when lying over massive gangrene, and neither the cutaneous changes nor any clinically demonstrable gas are as extensive as the involvement of the underlying muscle.

Infection spreads up and down the muscle from the site of the wound but *has little tendency to spread to other healthy muscles.* Even in well-established gas gangrene, the bloodstream is rarely invaded by Clostridia until immediately before death.

The muscle changes are usually only seen at operation. In the early stages, they consist of little more than swelling and pallor. Later, the colour alters to a lustreless pinkish-grey, then to brick red, then to a very typical slate blue colour and finally to a dark green purple.

Early and adequate surgery will prevent gas gangrene in missile wounds.

Thorough excision of dead tissue, which might necessitate urgent amputation, together with the early use of penicillin, will virtually eliminate gas gangrene.

When surgery is delayed, as may occur in wartime or in a civilian disaster with mass casualties, the risk of gas gangrene increases. All patients with missile wounds should receive prophylactic antibiotics, such as penicillin and erythromycin, which are effective against Clostridia organisms. But the antibiotics can only reach tissues with a blood supply and good tissue perfusion. Dead muscle allows diffusion only, and antibiotic concentrations in the depths of the wound are very low and ineffective.

ANAEROBIC CELLULITIS

Anaerobic cellulitis is an infection involving necrotic tissue resulting from ischaemia or direct trauma.

Spreading superficial gangrene of the abdominal wall is a similar condition causing necrosis and gangrene of the superficial tissues.

In neither case are healthy muscles involved, and the clinical picture is less dramatic than in gas gangrene. Treatment required is:

- the excision of necrotic tissue and the relief of tension,
- leaving the wound open for delayed primary closure,
- giving antibiotics.

9. TREATMENT OF NEGLECTED AND MISMANAGED WOUNDS

Many patients arriving at hospitals in war zones have wounds which were inflicted more than 24 hours previously, and some have wounds that are many days old. Some of these wounds will have received no treatment other than inadequate dressing, some will have had cursory excision and dressing, and some will have been sutured, generally without any form of excision. All these wounds require excision, and all sutured wounds, no matter how clean they appear, must have their sutures removed.

Remove all sutures from previously sutured wounds.

Delayed treatment (of wounds more than 24 hours old) or mismanaged wounds pose special management problems.

SURGICAL EXCISION

Surgical excision is a more difficult procedure in these wounds. The distinction between viable and non-viable tissue, especially muscle and fascia, is less obvious, and the extent of adequate excision is more difficult to assess than in a fresh wound. But the principles are the same, and *excision is directed towards the removal of all non-viable tissue.*

Contractility is still the best indication of muscle viability, but this is only valid if the patient is not under the influence of a paralysing anaesthetic agent. Grossly infected fascia is usually shredded and dull grey, while healthy fascia is a glistening white

structure. The presence of a bleeding capillary bed, immediately superficial to the fascia, indicates viability. Foreign bodies should be removed if encountered but there is no point in enthusiastically searching for them, as damage may be caused to viable tissue and infection may be spread.

Wounds should be dressed as for routine surgical excision (see chapter 6). Penicillin should be given prophylactically, according to the antibiotic protocol (see chapter 8). No topical antibiotics or antiseptics should be used. Because surgical excision is more difficult in these wounds, there is a higher incidence of persistent infection. In such circumstances, re-excision becomes necessary and the wound should be managed as before. Bacterial culture should be done, if possible, to identify the need for other antibiotics to treat the infection. *The indications that a wound is infected are the development of an offensively smelling, moist or overtly pussy dressing and/or the development of pyrexia.*

Infected wounds require re-excision, not ward dressings.

CLOSURE

The primary phase of wound healing begins at the time of wounding and is, therefore, well established by the time of presentation if the wound is several days old. With the addition of surgical excision, many wounds cannot be closed within seven days, in total, from the time of injury. If direct suture is attempted the wound edges can only be approximated under considerable tension, and extensive undermining of the skin edges to allow closure will often be associated with a large subcutaneous dead space and haematoma. Wounds treated in this fashion have a high incidence of infection and breakdown.

This is not delayed primary closure and should not be regarded as such. The majority of these wounds are unsuitable for DPC and require skin grafting, or specifically designed skin flaps, for closure.

Most delayed or neglected wounds will be unsuitable for delayed primary closure.

10. WOUNDS OF LIMBS

Some 50-75% of all missile wounds and blast injuries involve the limbs. The management of soft tissue damage is described in chapter 6. Special consideration must be given to the frequently associated fractures, and damaged blood vessels and nerves.

FIRST AID

Open missile wounds should be covered by a sterile, or clean, dressing before application of splints. Splints should be simple and effective. They are intended to immobilize the limb so as to reduce pain and prevent further damage to soft tissues by the fractured bone.

The arm may be bandaged to the side or a sling may be used. The leg can usually be splinted to the good leg, after padding protruding points, or it may be immobilized using some form of emergency splint.

Particular attention should be paid to the vascular and nerve supply of the limb before splints are applied.

MANAGEMENT IN ADMISSION AREA

Careful assessment of the probable blood loss must be made and measures must be taken to prevent haemorrhagic shock. A vascular and neurological assessment of the extremity distal to the injury must be made. Tetanus toxoid and penicillin should be given. X-rays are not required routinely, and judgement is necessary to determine which patients need X-ray.

INITIAL WOUND MANAGEMENT

Access should be through generous skin incisions, usually in the long axis of the extremity, with deviation in the usual manner if incisions cross flexion creases. *Deep fascia must be divided throughout the length of the incision* to allow adequate exposure.

There is often a large haematoma with considerable pulped muscle tissue, debris and foreign material. Bone will commonly be shattered into numerous fragments, either with soft tissue or periosteum attachment. Fragments of bone without any attachment should be discarded. Soft tissues should be excised as described above (see chapter 6) and the major ends of the bone should be aligned.

Major blood vessels must be repaired.

Severed nerves should be fixed to prevent retraction and their position noted. *Do not repair primarily.*

Damaged parts of severed tendons should be excised and loose frayed edges trimmed. *Do not suture primarily.*

Fractures can be stabilized with skeletal traction or plasters at the first operation.

Internal fixation is contra-indicated in war surgery.

At the completion of surgery, a check should be made that all dead tissue has been excised and that there is adequate decompression of compartments enclosed by fascia and under tension. All wounds should be left open for delayed closure. Dry gauze should be placed on, but not packed into, the wounds. This should be covered with bulky fluffed-up gauze, so as to easily allow free drainage. The dressing should be fixed with non-circumferential strapping. Plaster slabs can be applied but all plasters must be well padded.

TECHNIQUE OF DECOMPRESSION (Figure 1)

If there is any suspicion of compartment syndrome, decompression must be performed without delay.

Fascial compartment compression most commonly occurs with small penetrating wounds of the leg. It is frequently unrecognized.

Anaesthesia dorsally between the first and second toes (anterior tibial nerve) may be the only clinical indication of lateral compartment compression.

Signs of compartment syndrome:

- severe pain;
- impaired movement of toes and ankle;
- numbness of foot;
- pallor;
- leg hard and tense.

FIGURE 1

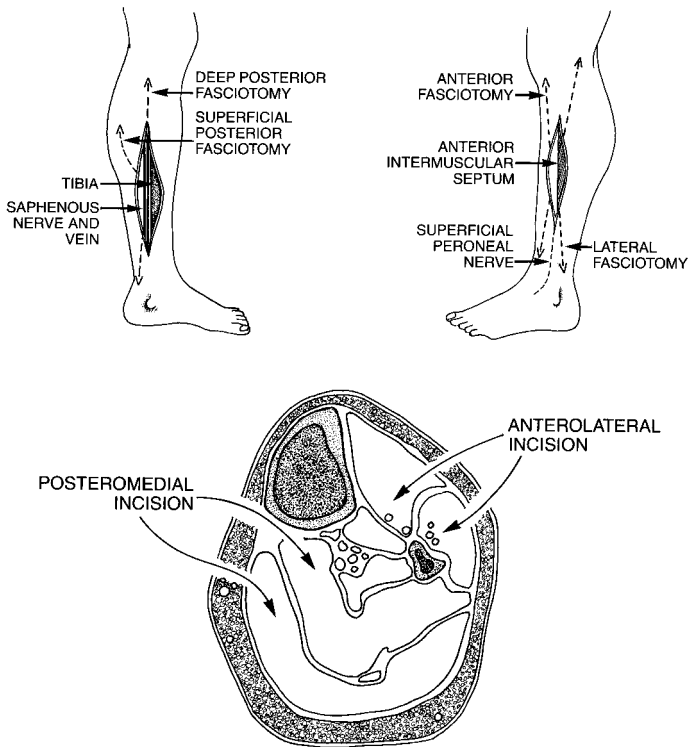

Fasciotomy incision approaches.

The *anterior and lateral fascial compartments* are approached through a single longitudinal incision 15 cm in length placed halfway down the leg, 2 cm anterior to the shaft of the fibula. This places the incision approximately over the anterior inter-muscular septum dividing the anterior and lateral compartments, and allows easy access to both. The septum is identified, and a nick is made in the fascia of the anterior compartment mid-way between the septum and the crest of the tibia. The fascia is opened proximally and distally with long round-ended scissors. The lateral compartment fasciotomy is made in line with the shaft of the fibula.

The *two posterior compartments* are best approached through a single longitudinal incision 15 cm in length in the distal part of the leg, 2 cm posterior to the palpable posteromedial edge of the tibia. The deep posterior compartment is readily accessible, and its fascia is opened distally and proximally under the belly of the soleus muscle. A second incision, 2 cm posterior and parallel to the first, gives access to the superficial posterior compartment.

The wounds should be left open for delayed closure.

Indications for fasciotomy:

- wounds directly involving the calf;
- concomitant major venous injuries;
- clinical compartment compression syndrome in the immediate postoperative period;
- when the ischaemic state has existed for longer than 4-6 hours before arterial surgery;
- any major arterial injury to the limbs.

METHODS OF IMMOBILIZATION

All severe wounds of extremities must be immobilized by splinting. Fractures should initially be immobilized using plaster of Paris (POP) or by skeletal traction, according to conventional practice.

Plaster splinting

Principles of cast application

Swelling occurs in a limb within the first 24 – 48 hours after a fracture, severe sprain, wound or operation; slabs or cylinders that have been well split are the only safe plasters to apply in these cases.

Never put a complete, unsplit, unpadded cylinder on a freshly fractured, wounded or operated limb.

Circulation can be impaired by tight bandages applied to a limb over a plaster slab, or applied directly over skin flaps. Tight bands over the front of the ankle or the front of the tibia have often caused partial or full thickness skin loss.

Never put a tight bandage over skin flaps or on the front of the leg or ankle when securing a plaster of Paris back slab.

A limb that is painful under a cylinder cast can be relieved of pressure by windowing, splitting or bivalving the cast, the bandages and the padding beneath the cast.

Painful plasters should be removed, partly or wholly, or split to expose the skin.

When immobilizing shaft fractures of long bones, the joints above and below the fracture site should be included in the cast.

The joints should be at an angle to prevent rotation of the limb in the cast. The knee is usually placed at 15° of flexion, the elbow at 90° of flexion. The ankle joint should be immobilized in the neutral position (90° to the leg) because plantar flexion (equinus) can become a permanent deformity. If a freshly fractured ankle cannot be reduced to the neutral position in the first cast, the position should be corrected when the second cast is applied.

Leg and arm casts should allow full range of movement of metatarsophalangeal (MTP), metacarpophalangeal (MCP) and interphalangeal joints unless these need splinting because of injury.

In hand injuries the preferred position of immobilization is 90° flexion of the MCP joints and full extension of the proximal interphalangeal and distal interphalangeal joints. This is because the capsular ligaments at the MCP joints are slack in extension and will shorten if immobilized in extension. The reverse is true of proximal interphalangeal and distal interphalangeal joints, which should be immobilized in extension.

Tools and equipment

The basic essentials needed to perform satisfactory plaster splinting are:

- (a) *Plaster bandages*: should be kept in airtight containers because plaster absorbs moisture and quickly becomes crumbly. Do not put wet hands or damp rolls of plaster in the container.
- (b) *Stockinet*: of various widths to fit forearm, arm, leg, thigh and trunk (5, 7.5, 10, 12.5 and 20 cm).
- (c) *Plaster wool*: also known as cellulose padding (10 and 15 cm widths).
- (d) *Adhesive and nonadhesive orthopaedic felt*.
- (e) *Kramer wire or strips of wood*: for reinforcing plaster and for making bridges over wounds that need to be dressed.
- (f) *Walking heels*: if not readily available, these can be made from old vehicle tyres, hard wood or plaster of Paris shaped as a 5 cm cube. The axis of the walking heel should be just in front of the intermalleolar plane.
- (g) *Plaster shears, knives, scissors and spreaders*.
- (h) *Strips of rubber*: 5 cm width. These are useful when plasters are split following application. The rubber strip is placed under the plaster cast as it is applied. The cast can then be split with a knife, cutting down on the rubber without danger of cutting the patient. The rubber can be pulled out as the plaster is cut.
- (i) *Electric plaster cutter*. Theoretically, the oscillating blade cannot cut soft material that vibrates and therefore it should not cut skin. However, if the skin is closely pressed to the cast, or is adherent to hard dressings soaked in blood, the skin can be cut quite severely. The electric cutter should also be used with great caution over bony prominences.

Be careful when using an electric plaster cutter. It can cut skin.

- (j) *Large screwdriver*: this is useful for spreading, opening and levering plasters.
- (k) *Smooth metal strip*: to be inserted under plaster when it is to be cut down on for removal or splitting.

Techniques

Padded plaster of Paris slab splint (Figure 2)

A most useful “slab” splint for short arm, long arm, short leg or long leg is made as a plaster and wool sandwich. First a layer of dry cellulose padding is taken, then a slab of wet plaster is placed on it, then another layer of dry padding completes the sandwich. This splint is then bandaged to the limb and allowed to harden. It does not adhere to the patient, or to the bandage, and can be removed and reapplied easily.

FIGURE 2

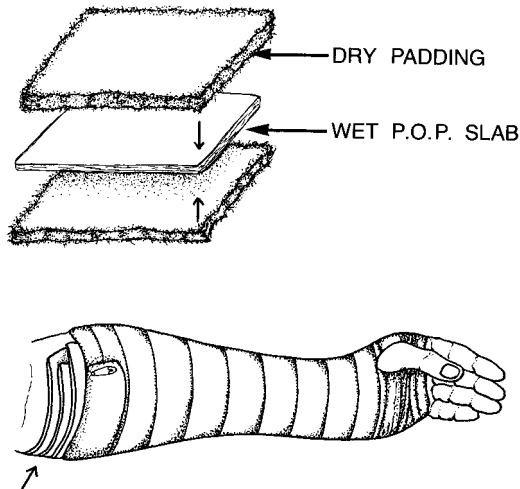

Padded plaster of Paris slab splint. The sandwich so formed does not adhere to the patient or to the applied bandage, and can be removed easily.

The back slab is a useful immediate splint:

- for a limb which is awaiting definitive reduction;
- where a fracture has united but needs some protection until it fully consolidates;
- in a limb which is unsuitable for a plaster cylinder because of wounds or burns.

Six to eight layers of plaster are required to give adequate strength to the back slab. Plaster requirements are:

- for a short arm slab, whether volar, dorsal or side slab: a single roll of 10 cm or 15 cm plaster;
- for a long arm slab: 2 x 15 cm rolls;
- for a short leg back slab: 3 or 4 x 15 cm rolls;
- for a back slab to secure the knee, extending from above mid-thigh or below mid-calf: 5 or 6 x 15 cm rolls.

Cylinder techniques (Figure 3)

Following reduction of a fracture, for instance a forearm fracture, a wet slab is laid on the limb over Stockinet, with a small piece of wool over the bony prominence (for example, ulnar head). This is firmly bound in position with a gauze bandage until the plaster sets. When the plaster becomes firm, the gauze is removed and a crepe or elastic bandage is applied. This slab holds the fracture securely but does not completely surround the limb and it allows swelling to take place.

FIGURE 3

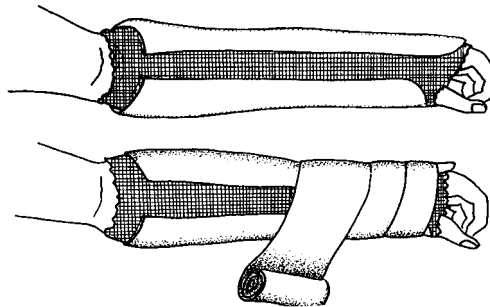

Post-reduction plaster slab convertible to a cylinder.

As the swelling subsides, after the third to fifth day, the plaster slab can be converted into a cylinder by adding circumferential turns of wet plaster. A strip of plaster wool should be laid over the skin exposed by the slab under the circumferential plaster so that the cast can be cut down on that line without danger. Skintight plasters have the disadvantage that they are difficult to remove. Well-padded casts have the disadvantage that they loosen as the swelling of the limbs subsides, and the fracture may become displaced.

Hand and finger casts

These are applied so that the MCP joints are flexed to 90° and the interphalangeal joints almost fully extended. If mobilization in an adult does not commence within ten days there is risk of some loss of range of movement of these joints.

Long arm cylinders

For *forearm shaft fractures*, casts should have a 90° bend at the elbow and extend up to the upper third of the humerus. The extension of plaster above the elbow is to prevent rotation of the forearm.

For *fractures and wounds involving the elbow joint*, a slightly more extended angle of the elbow is often necessary. Long arm cylinders should be padded with wool around the elbow and a turn of plaster wool at the upper end of the cast prevents chafing of the skin.

U-slabs

Fractures of the humerus can be held securely by a U-slab passing from well above the shoulder down over the lateral side of the arm, around the elbow and up the medial side to the sub-axilla. This should be applied over a layer of padding and secured to the arm with circumferential turns of plaster. The U-slab is put on with the elbow at 90° flexion; the forearm rests in a collar and cuff or a triangular sling bandage. A 15 cm bandage is used to secure the arm to the body.

Thoraco-brachial plasters

For *severe open fractures of the shoulder*, a thoraco-brachial plaster is applied. A well padded plaster jacket is put on over the

chest and shoulder. Then a large pad is placed in the axilla and a dressing on the wound. A U-slab is applied to the arm and then the plaster incorporated into the thoracic jacket by circumferential turns of plaster. The site of the wound should be marked on the plaster for windowing.

All U-slabs and thoraco-brachial plasters should be padded so that no sharp edge of plaster touches the skin.

Short leg casts

These are usually applied with the foot at a right angle to the leg and in neither valgus nor varus angulation. A persisting equinus or varus deformity is hard to correct. The knee should be free to bend.

Long leg casts

These should be applied with the knee flexed to at least 15° so that rotation at the fracture site cannot occur inside the plaster. There should be a layer of plaster wool over the bony prominences. If a slab is converted to a cylinder, a strip of wool is laid under the circumferential turns of plaster so that the cast can later be cut safely (as described above).

If the plaster is to be split immediately, a strip of rubber 5 cm wide placed lengthwise beneath the plaster is useful. When the plaster is split it should be split completely to the skin, making sure that no bandage or padding soaked in dry blood remains to compress the limb. The area just in front of the ankle is most at risk but pressure areas over the dorsum of the foot, the heel and the patella are common.

Long cylinders should extend from the upper third of the thigh to just behind the metatarsal heads. The toes should be free to flex and extend unless forefoot injuries make it necessary for the plaster platform to extend distal to the toes.

Wedging plasters (Figure 4)

Minor degrees of angulation can be corrected by the simple device of wedging and this can be done with perfect control. A linear cut is made round two-thirds of the plaster at the level of the

fracture on the concave side of the angle. Usually, no anaesthetic is required. The cut in the plaster is opened and held open with a small block of wood or cork, and replastered.

FIGURE 4

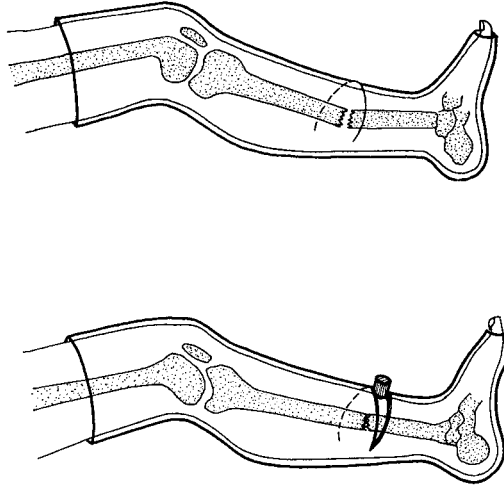

Wedging plaster, utilizing a small block of wood or cork.

The three-plaster method for long leg cylinders (Figure 5)

This is useful for *displaced fractures of the tibia*. One plaster is applied to the thigh, knee and leg to just above the fracture, with the knee at 15° of flexion. A second plaster is applied from just below the fracture to the foot, with the ankle at right angles. With the upper and lower fragments thus under control, traction or correction of any angulation can be carried out easily. The two casts are then joined by a third which is put on over a turn of cotton wool around the fracture site. The third plaster can be cut down upon, removed and replaced if necessary for further correction.

If *traction* is used to correct the position of the fracture, it *must be completely released* before the third plaster is put on, otherwise the patient will develop pressure effects on the heel, dorsum of the foot and patella. *Correctly used, this is a most useful method of cast application.*

FIGURE 5

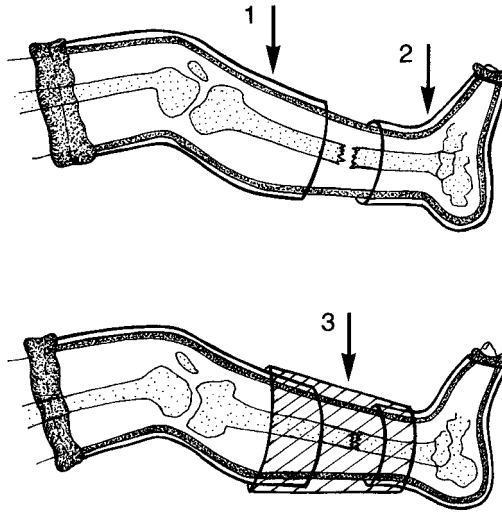

Three-plaster method for long leg cylinders:
1 = upper cast placed first; 2 = lower cast placed second (note the cotton padding extending the length of the combined casts); 3 = middle cast applied.

Spica

The hip spica is a useful method of immobilizing a fractured femur, especially in children over the age of four. It holds the fracture in a better position than is usually obtained with a Braun-Böhler frame, and it allows the patient to be up and about with crutches.

Patients like the advantages of a well-fitting spica and they can be sent from an active surgical ward to their own home or to a minimum care ward. This is one way of clearing beds satisfactorily in rush periods. *Spicas are good for cases of comminuted open fractures of the hip*; they can also be windowed.

The application of a spica needs a sacral rest, a perineal post, a head and upper thoracic rest, a sling under the knee to hold the knee and hip in slight flexion, and a foot rest. The foot is not usually included in the spica. A portable or improvised spica table or orthopaedic table is essential for the correct application of a spica. Padding must be adequate to prevent pressure effects.

Shoulder spicas

These are used in cases where the *shoulder is likely to be ankylosed or arthrodesed*.

They are applied with the arm abducted 70°, flexed 30° in front of the body plane and externally rotated 30°.

Windows and bridges

Windows allow dressings to be carried out. After being cut, they should be replaced and secured with bandages to prevent oedema and swelling of the soft tissues through the windows.

Bridges are a very satisfactory method of allowing large wounds of the leg to be dressed easily. This particularly applies to *wounds of the calf and heel*. The Kramer wire is secured to the plaster by circumferential turns at the ends of the bridge. Two or even three bridges allow the cast to be cut well away from the wound and dressings applied. Pressure effects on the heel can be prevented by allowing the sole of the foot to rest against the plaster of Paris cast. The cast over the heel can be detachable and well padded.

Traction

Traction is a simple and safe method of fracture-holding, especially for fractures of the lower limb. It can be used for initial and definitive stabilization, and allows easy wound access and joint mobilization. The disadvantages are long bed rest and sometimes difficulties in getting a good alignment of the fracture.

Techniques

(a) *Skin traction*. This is applied with adhesive strapping. It is useful for children, but for older children there is a risk that the skin will come off when necessary weight is put on. For babies, it is applied as “gallow traction” on both legs which are hung up above the patient with hips in 90° flexion.

(b) *Pin traction*. For femur fractures, a Steinmann pin is inserted with local anaesthesia 2.5 cm below the tibial tubercle. If there is a wound needing excision at the same time, general anaesthesia (ketamine) will be used.

The skin is incised with a knife and the hole is made with a hand drill. The pin sites should be dressed with gauze soaked in anti-septic solution. The leg is rested in a Braun-Böhler splint and 1 kg per 10 kg body weight is applied.

Pins in the distal femur should be avoided since they will cause tethering of the muscles and impaired movement of the knee joint. For tibial fractures, calcaneus traction can be used.

Postoperative check-up

The position in bed should be checked several times a day for the first few weeks.

After one week, X-ray will show whether the fracture is in a good position. If not, weights might be added or removed and padding under or around the fracture applied to support the position.

Pin care is essential. Dressings must initially be changed every second or third day. If there are signs of infection, such as pain, pus or loosening of the pin, the pin must be removed.

Infected pins must be removed.

Physiotherapy should be started as soon as the pain has subsided. Joints can usually be moved after one week.

X-ray control is done to check the position, but weekly clinical assessment is enough to check healing. The weight is temporarily removed and the fracture site palpated. If there is callus, and no pain or movement, traction can be discarded. This is usually after four to six weeks. Muscle exercises are done in bed for a week before the patient can start walking with crutches. The fracture area can initially be protected by plaster of Paris splints. Weight-bearing is started when there is no pain in the fracture.

POSTOPERATIVE FOLLOW-UP

Wound

The wound should be left untouched for five days. If signs of infection develop, such as increased oozing with an offensive smell and pyrexia, the wound should be checked earlier. After five days the wound should be clean and healthy, provided surgical excision has been adequate. The oedema of soft tissues should have settled and it is the optimum time for *delayed primary closure*. If the wound cannot be closed without tension, *skin grafting* and/or local skin flaps should be used.

Constant vigilance must be maintained at all stages of treatment following missile wounds of limbs so that the onset of vascular complication or infection is detected. Severe increasing pain beneath plasters, in association with pain on passive extension of the fingers or passive plantar flexion of the toes, is an indication of *compartment compression*. Pain that is out of proportion to that expected with the injury, associated with a rising pulse rate, demands immediate inspection of the limb in the theatre. All plaster and dressing must be removed so that the development of gas gangrene can be detected.

Definitive fracture holding

At the time of delayed primary closure, a decision can be made about which method should be used for the definitive holding of fractures:

- (a) *Plaster of Paris (POP)*. Continue backslab or convert to a cylinder, with window if necessary.
- (b) *Continued traction*. It is possible to adjust the position of the fracture, as the patient is anyway under light anaesthesia.
- (c) *External skeletal fixation*. Now is the proper time to apply an external fixator for fractures which are difficult to keep in a good position using POP or where the soft tissue wounds are big and still need dressing.

External skeletal fixation

External fixation is useful:

- in compound or open fractures,
- especially in fractures associated with major soft tissue defects.

The bone best managed by external fixation is the tibia. External fixation is also useful in the management of pelvic disruption.

There are several external fixation systems. The Mini-Set fixation system can be used to treat fractures of the lower arm, wrist, hand, foot and mandible. The system used in ICRC hospitals is the AO/ASIF tubular system.

The main advantage of external fixation is that it allows easier management of soft tissue injury. The surgeon must be completely familiar with the system and its use before using external fixators.

General technique

- (a) Alignment of the fractures, both axially and rotationally, must be obtained.
- (b) Cutaneous stab incisions must be large enough to prevent skin tension and pressure around the pin and screw.

Do not puncture the skin with pins or screws.

- (c) Predrilling should be done through the drill sleeve, so as to avoid damaging soft tissue.
- (d) Pin insertion should be achieved using the hand chuck with a back-and-forth twisting motion, *not* by power drill or by hammer. The pin should be delivered by stab incision on the opposite side.
- (e) Schanz screw thread length should be determined.
- (f) The Schanz screw should be inserted until the shoulder engages the cortex.

Application technique

- (a) Alignment of fractures using the uninjured limb as a reference.
- (b) Insert a Schanz screw or Steinmann pin into a main fragment as close to the joint as possible. A distance of 2-3 cm from the joint should be maintained:
 - tibia: anterior crest;
 - femur: lateral thigh;
 - pelvis: anterior-superior iliac spine.
- (c) Select a tube of appropriate length and place adjustable clamps on the tube (2 for pelvis, 4 for tibia, 6 for femur). Connect the end clamp to the inserted Schanz screw or Steinmann pin.
- (d) Insert a second screw or pin through the adjustable clamp and into the other main fragment, as near to the second joint as possible. With slight distraction of the fractured fragments, manual reduction is completed. Tightening of the most proximal and distal clamps to the tube will secure the reduction. Check the axial and rotational alignment of the main fragments prior to insertion of the remaining screws or pins.
- (e) Insert the remaining screws and pins through the remaining clamps. It is essential to have the screws in the same plane. A screw should be no closer than 2 cm to the fracture.

- (f) Preloading: loosen the adjustable clamps. Bend the Schanz screws or Steinmann pins towards each other in the same fragment, and retighten the nuts.
- (g) Release any skin tension around screws and pins by extending the incision.
- (h) Fill the “dead space” between the skin, screws or pins, clamps and rods with sterile, bulky gauze dressing. The pin sites should be covered with separate gauze pads. The whole bulky gauze dressing should be held in place with elastic strapping or bandages.
- (i) X-ray control of the position of the pins and the fracture should be done as soon as possible and necessary adjustments done.
- (j) One week after operation, provided the pin sites are free of tension, *routine daily antiseptic swabbing of the entrance points* should commence. The pins and skin should be cleansed twice daily with cotton swabs soaked in antiseptic solution. This should be continued for 10 – 15 days.

Pin track infection is treated by removing the pin involved.

Duration of external fixation

The fixator should be removed and replaced by a plaster cast as soon as soft tissues are healed. Removal of external fixators is painful and should be carried out in the operating theatre under light general anaesthesia, such as ketamine.

Fixators should be removed and replaced by plaster casts as soon as possible.

JOINTS

Wounds of joints may be explored by extending the laceration, or through a separate standard incision. Tourniquets must always be used to provide a bloodless operation field. No tourniquet should be left in situ for more than 90 minutes. All loose bony fragments, detached or badly damaged cartilage, foreign bodies,

debris and blood clots should be removed. Damaged tissue must be excised. All recesses must be thoroughly explored to make sure that no damaged tissue, or foreign body, is left behind. The joint should be irrigated thoroughly with saline until all remaining minor debris has been flushed out. The synovium should be closed and the remaining tissue left open for delayed primary closure. If the synovium cannot be closed, the capsule should be closed.

Joint injuries should be dressed in the standard fashion, leaving superficial tissue completely open. The joint should be immobilized in the position of function, using a well padded plaster that has been split to the skin.

After delayed primary closure and a period of immobilization (10-14 days), the joint should be mobilized cautiously.

If infection ensues, the joint should be re-operated, with removal of dead tissue, debris and blood clots by excision and copious irrigation. The antibiotic cover should be reviewed.

Old joint wounds, with established infection, should be treated in the same way.

HAND AND FOOT WOUNDS

Injuries to the hands and feet are common in cases of multiple wounds but they are often the last to receive attention.

First aid

After covering the wounds with sterile or clean dressings, and necessary splinting, the limb should be elevated to minimize swelling.

Primary surgery and management

Examination of the injured limb should be performed without anaesthesia in a good light. The presence of soft tissue damage, neurological defects and vascular injury must be recorded.

Wound exploration should be performed under adequate anaesthesia, with tourniquet control, in the theatre. The wound should be washed copiously with saline. A minimal amount of skin edge should be excised and all viable skin should be saved, remembering that skin is the most valuable tissue of an extremity.

Hand incisions should follow skin creases. In the foot, longitudinal incisions between the metatarsal heads are best.

Do not try to reach the palm of the hand or the sole of the foot from the dorsal side.

In order to get better access to deep structures, and to release tension, fasciotomies of the palmar fascia and the transverse carpal ligament are mandatory. Otherwise, the principles of wound excision are as described above (see chapter 6). At the end of excision, the tourniquet is released to confirm the viability of the remaining musculature. Major bleeding vessels must be ligated, small ones may be stopped by pressure.

Damaged nerves should be tagged and recorded but not repaired primarily.
Injured tendons should be trimmed but not repaired primarily.

Fractured bones should be cleaned with copious irrigation and curettage. Only irretrievably damaged digits should be amputated. Bones should be aligned, and attempts made to maintain the length of the second and fourth metacarpals in order to maintain the structure of the hand. All viable skin, even of grossly damaged digits, should be saved.

Wounds should be left open. They must be covered with well fluffed gauze.

Joints should be immobilized by splints in the following positions:

Hand

wrist:	dorsiflexion 30°
metacarpophalangeal (MCP) joints:	flexion 70°
interphalangeal (IP) joints:	flexion 10-15°
thumb:	well abducted.

Foot

ankle:	dorsiflexion 90°
--------	------------------

Unaffected digits should be left free to move.

The tips of digits should be left exposed so that the adequacy of blood supply can be monitored.

The limb should be elevated to reduce oedema.

Delayed primary closure should be performed after 3-5 days for hands, and 6-8 days for feet.

INJURIES OF PERIPHERAL NERVES

Peripheral nerves may be injured alone or, more commonly, in association with vascular damage or long bone fractures. In multiple injuries, nerve repair is of the lowest priority. Nerve repairs are performed when wounds are healthy and clean, which is generally at least 6 weeks after injury. Repair can safely be deferred for 3 months but *contractures must not be permitted to develop*.

Primary surgery

Nerve injuries should be noted during wound excision and the divided ends may be tacked to surrounding tissue to prevent retraction. Exposed nerves should be covered with muscle or fat. The limbs should be elevated to lessen oedema and padded plasters can be used to prevent the development of contractures.

Delayed primary suture

Nerve repair is contra-indicated at the primary stage because:

- there is a risk of infection;
- the extent of the damage to the nerve may be greater than macroscopically apparent;
- the extensive dissection to mobilize a nerve for suture without tension may spread infection;
- the nerve sheath is friable and becomes stronger later.

The aim of surgery at the primary stage is to obtain uncomplicated wound healing with minimum scarring.

Postoperative care

The object of treatment is to maintain mobility of joints affected by paralysed muscles. Active and passive joint movements are

commenced as soon as possible. Patients must be instructed to perform movements by themselves.

Splints should be simple:

- metal or POP splint to prevent wrist-drop is used in *radial nerve palsy*;
 - small improvised finger splints of metal prevent clawing of the fingers, in *ulnar nerve lesions*;
 - a piece of adhesive tape to hold the thumb in opposition during the night is used for *median nerve lesions*;
 - the foot should be placed at right angles to prevent contracture using a night splint in *sciatic and lateral peroneal nerve lesions*.
- Elective repair is performed when wounds have healed.

VASCULAR INJURIES

A high index of suspicion of vascular damage in any limb injury is essential. The position of the missile track, or the presence of a subfascial haematoma, indicates possible vascular injury. If, after resuscitation, distal pulses remain impalpable, urgent surgical exposure of the possible site of vascular injury is indicated.

“LOOK AND SEE” is wiser than “wait and see”.

Types of vascular injury:

- *Complete transection*: usually accompanied by loss of a variable length of vessel;
- *Arterial laceration*: vessel continuity remains but a portion of its wall is avulsed or torn open;
- *Arterial contusion*: usually occurs some distance from the track of a high velocity missile, or follows a blunt crushing type of injury with no external wound.

Management of arterial injury

Every effort should be made to repair arterial damage, because after major arterial ligation the incidence of limb gangrene is very high: 45-60% after axillary and brachial artery ligation; 80% after common femoral artery ligation; 45% after superficial femoral artery ligation; and 85% after popliteal artery ligation.

Arterial injuries should be treated as early as circumstances allow, preferably within six hours of injury. Bleeding vessels should be controlled by adequate proximal and distal exposure of the artery and the use of vascular clamps or slings.

Arterial laceration: direct repair by suture is possible only in small, clean cut lacerations of large arteries.

In large arterial defects, the distal and proximal arteries are controlled by arterial clamps, and the laceration is sutured using continuous 5-6/0 synthetic vascular suture. Sutures should be inserted 1 mm apart and about 1 mm from the wound edge.

As with any arterial anastomosis, bleeding through the suture line after release of the clamps should be controlled by packing for at least five minutes. Additional sutures should only be used if the bleeding continues.

Lacerations of small or medium sized arteries should not be sutured directly but the defect repaired with a patch graft of autogenous vein (Figure 6).

FIGURE 6

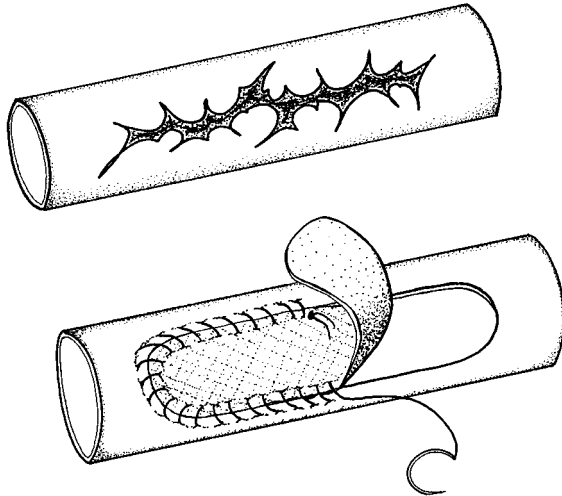

Repair of linear arterial laceration with a vein patch.

Complete transection: defects of up to 2 cm can be treated with direct end-to-end anastomosis, without tension, by mobilizing the

proximal and distal vessels (Figure 7). *More extensive damage requires replacement by saphenous vein graft* (Figure 8). The appropriate length of the long saphenous vein should be dissected cleanly and all branches tied carefully. Spasm of the graft can be reversed by dilatation of the segment with saline or blood. The vein segment must be reversed to obviate obstruction to flow from venous valves.

With small arteries, the damaged ends should be fashioned obliquely so as to enlarge the suture line area.

FIGURE 7

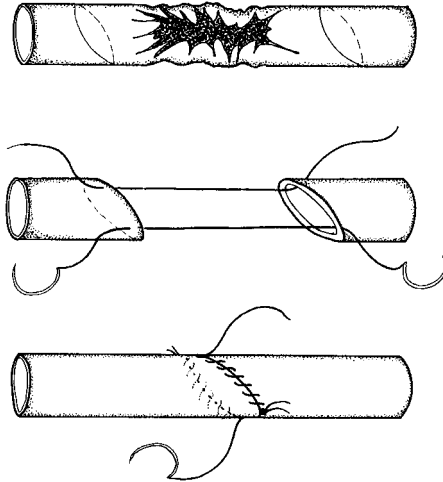

Excision of traumatized arterial segment with end-to-end anastomosis. Note the oblique line of transection.

Arterial contusions should be treated by replacement with vein graft, as the intimal damage is usually too extensive to allow resection and anastomosis (Figure 8).

FIGURE 8

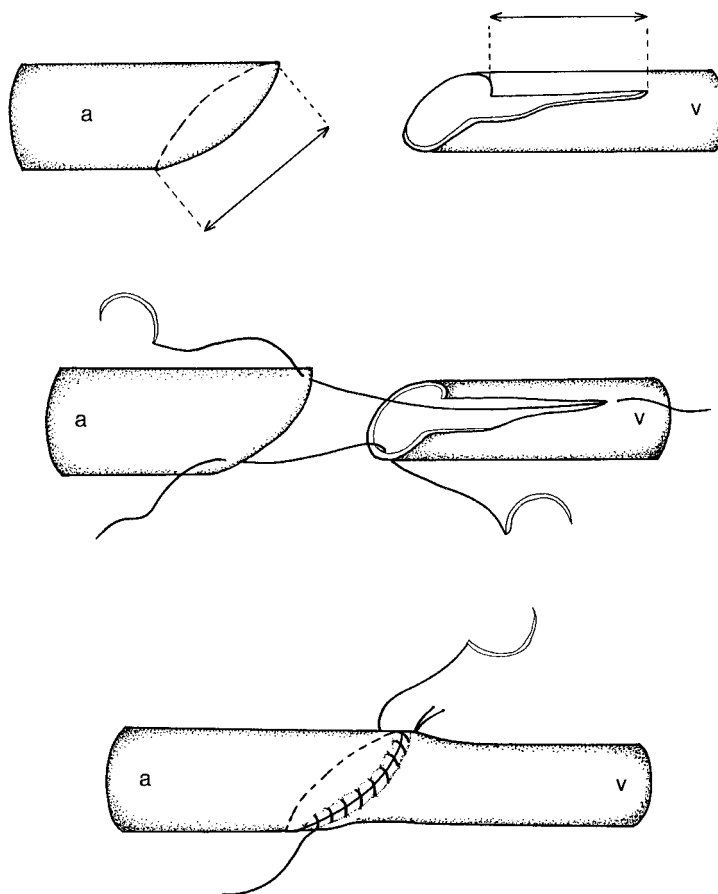

*End-to-end vein graft anastomosis after resection of length of damaged artery:
a = artery; v = vein.*

Most arterial damage associated with missile wounds results in large segment damage and must be repaired by saphenous vein grafts.

Arterial spasm is a very dangerous diagnosis. The artery concerned must be inspected directly and an arteriotomy performed to inspect the intimal surface.

Before arterial repair is completed, it is essential to check that free forward bleeding is obtained from the proximal segment, and that there is adequate back bleeding from the distal segment. If there is doubt about distal patency, a Fogarty balloon catheter should be carefully passed. The artery that has been repaired should be flushed with heparinized saline (5,000 U/100 ml saline) if available and this solution should be injected into the distal arterial tree. The anastomosis must be covered with viable tissues, preferably muscle belly.

Venous injuries: major veins should be repaired whenever possible. Lateral suture of lacerated veins is often possible because of the large diameter of the main venous trunks. In extensively damaged major trunks, autogenous vein patching or vein grafting will be required.

Compound fractures associated with arterial injuries: unstable fractures should be treated after vascular surgery either with gentle skeletal traction or external fixation.

Postoperative care

Circulation peripheral to the vascular repair must be checked regularly. Active muscle exercises should begin on the first day after operation whilst immobilization in bed is required. Walking is allowed after delayed primary closure of the soft tissue wounds.

AMPUTATIONS

A number of factors will influence the surgeon as to whether to amputate and at what level amputation should be performed. Rehabilitation services may offer only a limited variety of prostheses; restricted intensive nursing care may dictate amputation earlier than in other situations so as to save life; limited surgical experience and supplies may make vascular repair ill advised in order to save a limb. In some cultures, amputation will not be accepted at all, or not at the proper level initially, even if the patient's life might be at risk.

Surgical judgement is particularly delicate in a number of cases of limb salvage. The following indications are based on experience

and only offer guidance. The surgeon's decision will take account of actual circumstances.

General indications for amputation

Amputation is generally indicated when there is:

- (a) severe damage:
 - upper extremity*: no chance of recovery of function of any part of the hand, fingers or thumb;
 - lower extremity*: mangled, grossly contaminated wounds;
- (b) overwhelming infection;
- (c) established gangrene;
- (d) continued infection associated with severe nerve and bone injury;
- (e) secondary haemorrhage, uncontrollable by other measures;
- (f) multiple injuries, where amputation is the simplest and fastest means of removing excessive amounts of damaged muscle in order to save life.

Conservation of the knee joint is of great benefit because of the greater function of a limb with a normal knee. This is particularly important when both lower limbs are injured.

Conservation of a limb may sometimes be effected by a simple, single arterial suture or graft. An overall amputation rate of 50%, which existed when ligation of major arteries was practised, has been reduced to about 13% with associated vascular repair.

Popliteal artery injuries have a high amputation rate (up to 30%) even after arterial repair. Anaerobic cellulitis or myositis confined to a single muscle group can sometimes be managed by excision and extensive decompression of muscle compartments.

Level of amputation

The level of amputation should be at the lowest possible level of viable tissue. Good viable skin and soft tissue distal to the point of bone division should be saved for use in subsequent stump closure. Short tibial stumps can often be saved by posteriorly based skin flaps.

Guillotine amputation should not be performed. Long posterior flaps of skin, fascia and obliquely dissected muscles give a much better stump.

When deciding on the level of amputation, the surgeon must consider the skills of the local prosthetic workshop. Formal ampu-

tation should be performed at the site of election decided in conjunction with local prosthetists.

The sites of election for amputation are:

- tibia: 12-14 cm from the tibial tuberosity, with a minimum of 5 cm;
- knee disarticulation to minimize surgical trauma in weak patients;
- femur: 25-28 cm from the top of the great trochanter, with a minimum of 10 cm;
- arm: 6-8 cm above the elbow, with a minimum of 2.5 cm beyond the anterior axillary fold;
- forearm: 6-8 cm above the wrist, with a minimum of 2.5 cm of ulna beyond the prominence of the biceps tendon when the elbow is flexed.

Procedure

At the primary amputation, as much bone and soft tissue as possible are conserved. Standard flaps may not be possible and “flaps of opportunity” may have to be made.

Stockinet traction is not recommended.

In standard amputations, skin flaps should be cut longer than the thickness of the limb, from the level of bone section. The following guidelines are based on experience:

- fascia should be cut through at the same level as the skin;
- muscle should be cut obliquely back to the level of bone section;
- periosteum should not be reflected proximal to the site of bone division;
- major blood vessels should be doubly ligated, arteries and veins should be ligated individually;
- nerves should be divided as high as possible without strong traction, and should not be ligated;
- the artery accompanying a major nerve (sciatic, median) may need separate ligation;
- the fibula should be cut at least 2.5 cm shorter than the tibia and the sharp corner at the end of the tibia should be levelled;
- the radius and ulna should be divided at the same level;
- menisci should be removed in knee disarticulation.

The stump should not be closed primarily.

At delayed primary closure, the fascia should be closed over the bone to make sure that there is a mobile flap of skin over subcutaneous fat at the end of the stump. It is important that DPC is not delayed as skin retraction occurs rapidly but if done within 5-7 days it is never a problem. Stumps will always smell and look yellowish when taken down for DPC in the theatre, but the distinction must be made between the yellowish colour of fibrin and pus. DPC must never be performed over pus but the presence of fibrin will not adversely affect healing.

Skin grafting may be necessary if the flaps retract. Closure in cases with a very short below-knee stump can sometimes be effected by removing the whole of the fibula, and the tibia up to a minimal length, reducing the muscle bulk while preserving the fascia, and beginning partial DPC early.

Haematoma collection must be avoided. This is best accomplished by meticulous haemostasis and the liberal use of suction drains.

Stumps, especially below-knee amputations, must not be bandaged too tightly, as it is very easy to compromise the blood supply to the skin over the anterior surface of the tibia. Once healing has been established, firm bandaging to shape stumps is indicated.

In barefoot communities, a Syme's amputation is much preferred by the patient. Amputation at a higher level means the use of footwear or crutches. Good prostheses can be made for a Syme's stump.

11. CHEST INJURIES

Wounds of the thorax constitute 15-20% of all combat injuries. Many patients die from cardiac or major vascular injuries before reaching medical assistance. In a forward hospital, 7-10% of all war wounds may be expected to be chest injuries.

Establishment of adequate ventilation takes absolute precedence over all other therapeutic measures. Bleeding may also be critical. The treatment aims at re-establishing normal physiological functions.

More than 90% of all penetrating chest injuries can be managed initially by chest drain.

Active and appropriate treatment of shock will prevent or minimize postinjury complications.

When an airway and a large pulmonary vein are disrupted and are in communication, air embolism is possible if the pressure in the airway exceeds the pressure in the vein. This does not happen with normal spontaneous ventilation, but may occur with positive pressure ventilation. *Exercise caution in the administration of positive pressure when penetrating lung trauma is present.*

Initial radiography is of limited value. Even if an acute chest X-ray is considered to be of value, *diagnosis and treatment of immediately life threatening conditions* (hypovolaemia, respiratory insufficiency, massive haemothorax, tension pneumothorax, cardiac tamponade) *take precedence over X-rays.*

All patients should be given penicillin 5 million units i.v. 6-hourly, substituted by oral penicillin (500 mg 6-hourly) after 24 hours if the patient's condition permits.

The location of the entrance wound is usually in the lateral and lower thorax. It is an error to assume that the missile track proceeds along a straight line from the entrance site to the exit site, and such an assumption should not be used in predicting organ injury.

The incidence of concomitant abdominal injuries varies, but it ranges between 10% and 40%. Apart from wound excision and insertion of chest tubes, *overall the most common operation in penetrating chest injury is laparotomy.*

HAEMOTHORAX

Haemothorax or haemopneumothorax is present in most patients with intrathoracic war injuries. Operative control of the bleeding is seldom necessary. Haemorrhage from the lung parenchyma will stop spontaneously. Only laceration of a large hilar vessel, or an intercostal or internal mammary artery, or a subclavian vein or artery will continue to bleed and require operative haemostasis. In patients with perforation of the diaphragm, continued haemorrhage often has an intra-abdominal source. In about half of these patients, an intra-abdominal injury is responsible for the haemorrhagic shock.

Proper circulatory resuscitation should be instituted with crystalloids, such as Ringer's lactate solution. Blood should be given as indicated. Vigorous crystalloid resuscitation of injured patients does *not* increase formation of pulmonary oedema. Colloid solutions offer no proven advantages, and supplemental albumin resuscitation for hypovolaemic shock is contra-indicated.

Chest tubes should be inserted as soon as possible.

Thoracocentesis can be used as a diagnostic tool but has no place in the treatment of acute haemothorax.

PNEUMOTHORAX

Less than 20% of patients with penetrating war injuries of the chest have pneumothorax alone.

Air leaks will not be large if only the pulmonary parenchyma is injured. When full lung expansion and pleural apposition is achieved, the leak will cease within two or three days.

Tension pneumothorax is seldom seen in missile injuries. In stab wounds it occurs in less than 3% of cases. Acute tension pneumothoraces are managed by the creation of a vent made from a needle or a plastic cannula, with a slotted glove finger tied over the end of the tube (Figure 3).

CHEST TUBES

Insertion of chest tubes

Properly placed chest tubes are life saving and should be inserted as soon as possible.

When clinical signs of haemothorax or haemopneumothorax exist, insertion of intercostal tubes should be done before X-rays are taken.

Tubes are usually inserted under local anaesthesia but when there is a wound to excise ketamine might be more appropriate.

Insertion of mid-axillary (basal) chest tubes (Figure 1 a-c)

A straight size F 36 or F 40 tube, with multiple holes, should be placed through the fifth or sixth intercostal space in the mid-axillary line.

- (a) Thoracostomy sites should be positioned away from missile wounds and planned incisions. Clean the skin and give local anaesthesia. Anaesthetize the chest wall from the skin to the parietal pleura, including the neurovascular bundle.
- (b) Incise the skin in the mid-axillary line at or above the nipple line (*fifth or sixth intercostal space*) and, using blunt instruments, dissect a three centimetre long subcutaneous tunnel towards the posterior axillary line.
- (c) Continue the dissection with a curved haemostat through the intercostal muscles. Take care not to damage the nerve or intercostal vessels. Do not perforate the pleura.
- (d) Put a finger into the tunnel and enter the pleural space (Figure 1 b). Make sure with digital exploration that adhesions of pleura and lung are not present (for example, post tuberculosis). If there are adhesions, repeat steps (a) to (d) in another interspace.

FIGURE 1

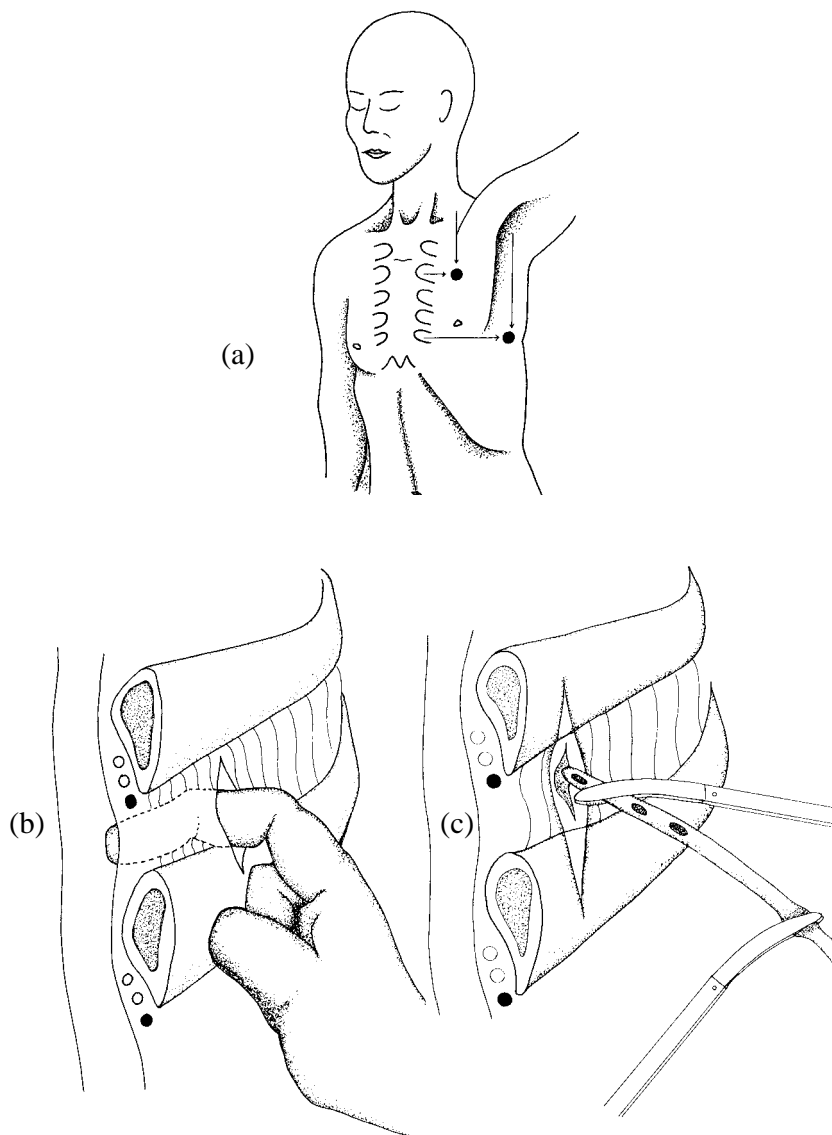

Insertion of basal and apical chest tubes.

- (e) Grasp the tip of the clamped tube with a curved haemostat and introduce it in a posterior direction (Figure 1 c). A good variation is to guide the tube in a posterior and inferior direction, into the phrenico-costal sulcus, offering ideal drainage of the lowest section of the thorax. Advance the tube along the thoracic wall until the side holes are well inside the pleural space.
- (f) Open the clamp on the tube and check that fluid or water vapour is discharged synchronously with breathing. Close the clamp again.
- (g) A heavy suture on each side of the tube is used to close the skin incision and to secure the chest tube. Place a purse string suture about the skin incision so that the incision can be closed when the tube is removed.
- (h) Connect the tube to an underwater seal, one-way valve and, if available, to a suction apparatus.

Insertion of mid-clavicular (apical) chest tube (Figure 1 a)

A size F 20 or F 24 tube should be inserted through the *second intercostal space* in the mid-clavicular line anteriorly, using the same technique as for mid-axillary tubes. The tube should be advanced upwards to the apex of the pleural space.

Trocar chest tubes are as dangerous as thoracocentesis needles and are often mistakenly placed in an upper abdominal or mediastinal organ. To avoid additional injury, *trocar tubes should never be used by those without great experience in their correct use.*

The size of the drains is important in enabling large volumes of blood to be drained, particularly as suction apparatus may not be available. If suction is not available, an elevated bed with the patient in a sitting position makes drains more effective.

Blood in the thoracic cavity rarely clots unless the haemothorax is so large that the lung is completely collapsed and thus unable to defibrinogenate the blood by its movements. When the drain has been inserted, as much blood as possible should be removed before it is connected to the underwater seal (Figure 2). An alternative is to use a Heimlich flutter valve, or to improvise one by tying a slotted rubber glove finger over the end of the tube (Figure 3). A suction apparatus is seldom necessary to evacuate blood and air.

FIGURE 2

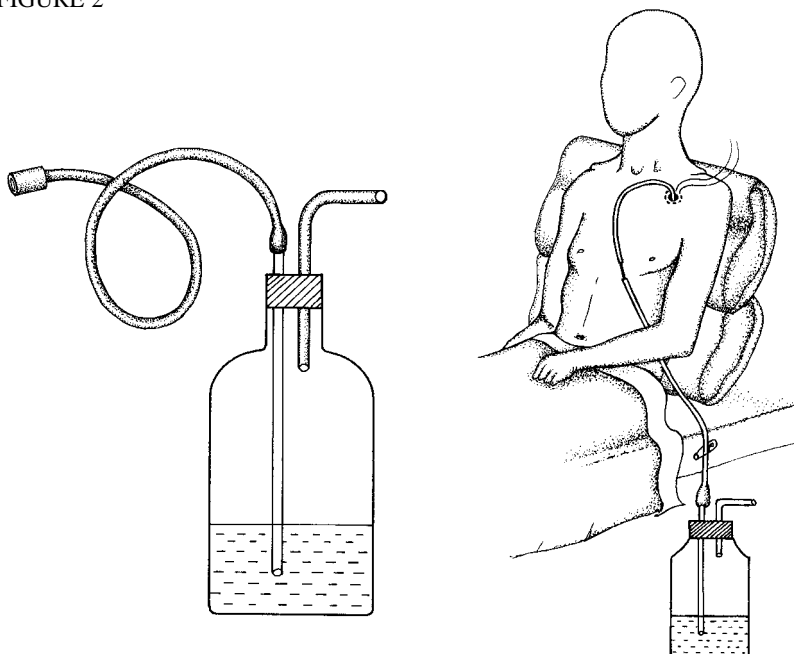

Underwater seal.

FIGURE 3

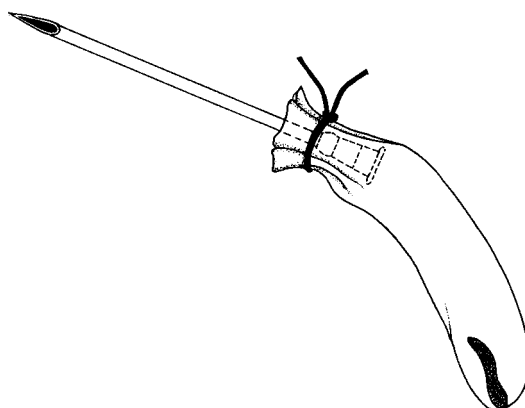

Improvised Heimlich flutter valve. A widebore canula is inserted at the upper edge of a rib. A finger from a surgeon's glove, with a 1 cm long incision in the end, is tied around the canula.

Postoperative controls

The clinical condition of the patient should be checked several times a day.

Deep-breathing exercises should be administered, preferably by a trained physiotherapist, for the period during which the intercostal tubes are in position. Adequate pain relief is essential.

The functioning of the drains must be checked. The fluid inside the drains should swing with each breath. If the drains are blocked, they can be flushed with normal saline. If this does not work, it might be necessary to replace the drains.

An X-ray one or two hours after inserting the drains is valuable in showing whether the lung has fully expanded. Where possible, X-ray is checked daily.

Removal of chest tubes

The decision to remove chest tubes is based on the following:

- (a) clinical assessment that the lung has re-expanded and tube drainage is very small (less than 75 ml/24 hours); or
- (b) radiographic evidence that the lung has adequately expanded and collections have drained to a minimum; and
- (c) the underwater seal has stopped swinging, *but is not blocked*.

Clamp the drains for one more day. If a pneumothorax does not recur, the tube may be removed. It is important to have the patient perform a Valsava manoeuvre when the tube is removed to ensure that no air is sucked in through the chest wall before the opening can be closed.

Physiotherapy should continue for several days following the removal of the tubes.

WOUND EXCISION

Entrance and exit wounds should be excised removing all devitalized tissue. Intercostal vascular bleeding is easily handled by ligation. The pleura and the deep muscle layer should be closed to ensure an airtight seal, leaving the outer layers open for delayed primary closure on the fifth day.

THORACOTOMY

Few patients need immediate thoracotomy.

The *indications* for thoracotomy are:

- (a) massive bleeding (more than 1000-1500 ml at the time of insertion of chest drains, and 200-300 ml/hour for 4 hours); the general condition of the patient and the time since injury must, however, also be taken into consideration;
- (b) persistent pleural air leak over 24 hours, or earlier if massive;
- (c) mediastinal injury; or
- (d) major defect of the chest wall.

Correct choice of *incision* is necessary for a successful thoracotomy. In war wounds of the chest, a lateral or an anterolateral incision should be made at the fourth or fifth intercostal space. Virtually all injuries, except those of the descending aorta and oesophagus, and rarely occurring injuries to the main bronchi, can be repaired through this incision.

Rupture of the aorta or great vessels is not commonly encountered. Oesophageal injury is also rare (0.5% of thoracic injuries).

Diaphragmatic rupture *is not* an indication for thoracotomy, despite the practice often mentioned in the literature. In most cases, the approach should be a laparotomy as there will frequently be an intra-abdominal injury.

OESOPHAGEAL INJURY

Oesophageal injury is very rare. All untreated patients die, while early primary closure, drainage and diversion results in a high incidence of survival.

If the diagnosis is suspected, the patient should be asked to swallow a few cubic centimetres of dilute methylene blue. The presence of an oesophageal injury will result in methylene blue appearing in the pleural cavity.

BRONCHIAL INJURY

The following suggest bronchial injury:

- (a) pneumothorax in which no expansion of the lung can be achieved with suction drainage;
- (b) obvious mediastinal emphysema;
- (c) appearance of atelectasis that cannot be corrected by usual conservative therapy;
- (d) haemoptysis, dyspnoea or subcutaneous emphysema.

Repair is best accomplished by primary closure.

CARDIAC INJURY

Of those reaching hospital alive, the majority will have a small wound with self-limiting haemorrhage. If pericardiocentesis (using the subxiphoid approach with a large-bore needle inserted at an angle of 45° directed towards the left shoulder) is unsuccessful in relieving cardiac tamponade, immediate thoracotomy is indicated.

If the initial aspiration was successful but signs of cardiac tamponade recur, surgical exploration is indicated.

Great care must be taken to identify and to avoid injury to the phrenic nerve as the pericardium is opened.

When suturing the myocardium it is important to use a large needle and a heavy suture to avoid laceration. A common error is to use small sutures which frequently convert a small tear into a large, stellate laceration.

Pericardial closure should be complete enough to prevent herniation of the heart into the left pleural cavity.

Pericardial tamponade is a clinical diagnosis. Chest X-ray is rarely of diagnostic value since the pericardium does not stretch acutely, and false widening of the heart and mediastinum on the typical anterior-posterior recumbent emergency X-ray is more misleading than helpful.

FLAIL CHEST

The flail segment has received too much attention. The real problem is the lung. Lung contusion will usually progress for 2-3 days and will resolve slowly. Aspiration at the time of injury is common, resulting in obstructive atelectasis.

Most patients with lung contusion can be managed without respirators if pain is relieved, secretions are eliminated and pulmonary oedema reduced. The paradoxical movement of the flail segment is frequently diminished or may even cease completely with proper nerve blocks. The explanation is, presumably, that optimal pain control reduces the effort of breathing.

Operative stabilization of multiple rib fractures results not only in restoration of mechanical stability, but also in pain relief.

Strapping the flail segment with a firm dressing or with elastoplast is often enough to stop flailing. A few heavy sutures tied over a plaster of Paris slab will also stabilize the segment.

Occasionally, the flail segment can be stabilized by skeletal traction.

Intercostal nerve blocks, frequent bronchial toilet including physiotherapy, diuretics and supplemental oxygen should be instituted. The fluid balance should be kept “on the dry side”.

THORACIC EMPYEMA

With vigorous conservative treatment of chest injuries using wide enough chest drains, empyema should rarely occur. The cause of empyema is failure to achieve complete evacuation of intrathoracic blood and re-expansion of the lung. If these are not achieved, antibiotics and other measures will not prevent empyema.

If empyema occurs, the well-established techniques of closed chest tube drainage followed by segmental rib resection and open thoracostomy drainage should be carried out. This can be accomplished under local anaesthesia, with minimal operative risk, and allows for the slow gradual and complete resolution of the underlying empyema cavity.

THORACOABDOMINAL INJURY

Thoracoabdominal wounds occur in 10-40% of thoracic injuries. In about 90% of thoracoabdominal wounds, the site of entry in the chest is below the sixth rib posteriorly and fourth rib anteriorly. In any penetrating wound at the level of the fourth intercostal space or lower, an intra-abdominal injury must be suspected.

Patients with thoracoabdominal injuries have thoracic wounds that can usually be managed by *closed tube chest drainage* and abdominal wounds that require *laparotomy*. The possibility of an associated abdominal injury must always be suspected. Mortality in trauma comes not from a negative laparotomy, but from a missed abdominal injury.

If both abdominal and thoracic explorations are necessary, separate incisions should be used when possible.

It is important to remember that an unrecognized perforation of the diaphragm during exploratory laparotomy becomes a sucking wound that can easily lead to tension pneumothorax.

A chest tube should be inserted routinely in all thoraco-abdominal wounds, especially those requiring laparotomy.

Never try a transthoracic approach to the abdomen if a diaphragmatic perforation is discovered during thoracotomy – it does not permit adequate exploration of the abdomen.

Perforations of the diaphragm should be closed carefully with strong synthetic absorbable sutures. Perforations along the posterior pulmonary sulcus are often overlooked.

INTERCOSTAL NERVE BLOCK (Figure 4)

Intercostal nerve blocks are useful methods of analgesia in all kinds of thoracic wall pain.

They only last a few hours, and repeated blocks are often necessary.

FIGURE 4

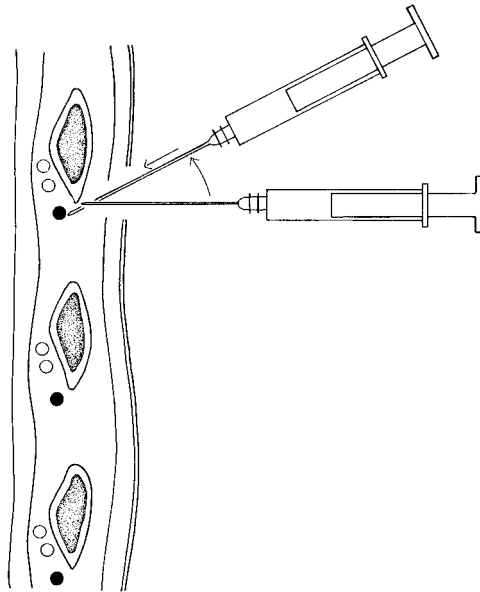

Intercostal nerve block.

The injection site should be dorsal of the posterior axillary line and lateral of the erector muscles.

The needle should be aimed at the lower margin of the rib. When contact with the rib is felt, the syringe is angled 30-45° upwards and the needle is advanced about 0.3 cm behind the lower border of the rib.

An aspiration test, to ensure the needle is not in a vessel or intrapleural, is carried out and local anaesthetic is injected.

The procedure is repeated 1-2 intercostal spaces above and below the injured area.

3-5 ml of lidocaine 10 mg/ml with adrenaline is normally used. Up to 500 mg may be injected in an adult.

2-3 ml of bupivacaine 5 mg/ml with adrenaline is an alternative. *Do not use more than 2 mg per kilo body weight.* Bupivacaine has a longer duration than lidocaine, but is much more expensive.

Epidural analgesia is a good alternative to intercostal nerve blocks, but thoracic epidural block is difficult and should only be done by an experienced anaesthetist.

12. ABDOMINAL WAR WOUNDS

About 10% of the patients brought to the field hospital alive have abdominal wounds. The percentage may be much smaller where there are long transfer times. The high energy transfer by bullets from rifles and machine guns, as well as shell fragments and shotgun pellets hitting at close range, cause extensive injuries, particularly in parenchymatous organs. These lesions are almost always instantly lethal. Therefore the majority of patients with abdominal lesions will have been hit by low-energy missiles, including bone fragments from fractures close to the abdominal cavity. The severity of the wound depends on which and how many abdominal organs have been hit. When major vessels have been hit and the patient is in shock on arrival, with external bleeding from the abdominal injury, the prognosis is usually grave. Between 25% and 40% of the abdominal wounds have associated thoracic wounds, and 5% have penetrated the perineum, buttocks or thighs.

In principle, all penetrating abdominal wounds should be explored: the mortality of a negative laparotomy is low, whereas an unoperated abdominal wound is often fatal.

Prognosis depends on three factors:

- the type of missile and amount of energy transferred;
- the organs hit and their number;
- the time since injury.

On arrival:

- (a) Examine the front and back of the abdomen carefully.
- (b) *Note the number of wounds.* There will often be several if the patient has been hit by a mine or shell fragments.

- (c) Attempt to estimate which organs have been damaged, based on the location of the wounds.
- (d) Be particularly aware of low thoracic lesions, and lesions of the perineum and buttocks, which may have involved the peritoneal cavity.
- (e) Remember that the patient may have a closed abdominal lesion caused by blunt trauma when he was blown over by the explosion, often causing rupture of the liver or spleen. Sometimes the blast pressure wave may cause rupture of air-containing viscera, without any external signs of injury.

Resuscitation includes:

- (a) A good *wide-bore intravenous line*. If the patient is in a poor condition, several lines may be necessary and, if possible, they should be inserted in the upper extremities.
- (b) A *urinary catheter*. This should be inserted in order to assess urinary output. It might also reveal unnoticed uro-genital lesions.
- (c) A *nasogastric tube*. The tube will prevent gastric dilatation and avoid gastric contents being aspirated into the lungs.
- (d) *Routine antibiotic treatment* is penicillin supplemented by metronidazole and chloramphenicol (see chapter 8). If surgery does not reveal a lesion of the colon, metronidazole may be suspended. *It is rarely necessary* – even with seriously wounded patients – to continue the treatment *for more than five days*.
- (e) Most abdominal cases can be treated without previous X-ray. An X-ray should not delay the treatment of a patient who needs urgent surgery.

MANAGEMENT PRIORITY

Laparotomy should be as early as the patient's condition permits, the time factor being of vital importance. Mortality and morbidity increase as the time interval between wounding and surgery lengthens.

Patients with intra-abdominal bleeding who are shocked should take priority over those who have intestinal perforations alone. Both conditions are potentially fatal.

Bleeding is the more immediate concern and is usually evident at an early stage through abdominal pain, rigidity, the absence of intestinal sounds, distension, and mounting degrees of shock.

Resuscitation is initiated as described above, and the patient is taken to the operating theatre. No more than two hours should be spent on resuscitation prior to surgery.

The highest priority should be given to patients in shock caused by bleeding which can only be controlled by surgery. *Once the bleeding has been controlled, there is time for further resuscitation.*

GENERAL SURGERY PLAN

1. The operation site is prepared so that the incision can be extended upwards to the thorax and downwards to the thighs.

2. *Midline incisions are preferred*; these may be extended from the xiphoid to the symphysis pubis. They are quick and provide excellent access.

As a general rule, a formal incision should be used rather than an extension of the abdominal wound.

Separate abdominal and thoracic incisions are preferred to a thoracoabdominal incision.

3. If the patient's condition permits, wounds of the back are excised before laparotomy because the patient may suffer serious shock if he is turned after the end of abdominal surgery.

Wounds in the anterior abdominal wall are excised after the abdominal surgery.

4. Most commonly, bleeding will be from the small bowel mesentery. Occasionally, it will be from large vessels of the posterior abdominal wall, which can only be identified by moving the entire small bowel out of the abdominal cavity.

Other sources of profuse bleeding are the liver and the spleen. Severe liver haemorrhage can be controlled temporarily by compressing the portal vein and the hepatic artery in the free edge of the lesser omentum. This can be combined with direct compression or packing of the liver wound. The bleeding points should be ligated using absorbable sutures.

Caution must be exercised when opening a retroperitoneal haematoma. The tamponade effect of the peritoneum may be

controlling an injury of a major vessel, and relieving the tamponade can result in massive haemorrhage.

5. *All organs must be inspected.* Inspect the alimentary tract carefully. Note if there is free intestinal content in the abdominal cavity. The surgeon must find and treat all perforations. They may be very small, and in unexpected places, but all are potentially fatal.

A faecal smell may be the only indication of a colonic injury.

6. The small bowel is the most frequently injured organ. Its whole length should be examined, from the duodeno-jejunal junction to the caecum. All injuries should be localized and marked with Allis forceps. To avoid further leakage, perforations should be at least temporarily closed by a simple suture. Final repair should be postponed until all injuries have been located, since resection may be more sensible than multiple repairs. The mesentery must be checked carefully, and bleeding spots should be sutured rather than ligated.
7. Colon: retroperitoneal haematoma, emphysema in the area of the ascending or descending colon, or a faecal smell, must lead to careful examination for lesions of the retroperitoneal surface. Mobilize the left and right colon, and expose the retroperitoneal surface for inspection.
8. Stomach and duodenum: if there is a lesion of the anterior surface of the stomach, there is often also a lesion of the posterior surface, which must be inspected by opening the gastro-colic omentum.

The second part of the duodenum is visualized by a Kocher manoeuvre (Figure 1). Bile staining might indicate pancreatic or duodenal injury (Figure 2). The third part of the duodenum is visualized by opening the mesocolic omentum and incising the duodeno-jejunal ligament. Special attention should be paid to the mesenteric vessels. Look for retroperitoneal haematoma and oedema.

FIGURE 1

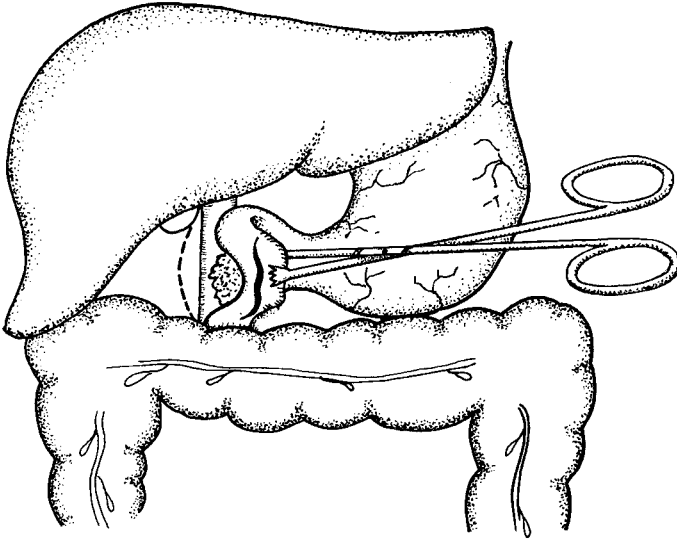

Kocher's manoeuvre. The second part of the duodenum is mobilized via an incision in the peritoneum lateral to the duodenum. The duodenum can be medially reflected so that the posterior surface can be inspected.

9. Finally, the rectum and the bladder should be examined. Perforations of the bladder should be examined with a finger.
10. All the lesions should be dealt with in the manner described below.
11. *Do not waste time looking for foreign bodies!*
12. At the end of the operation, the abdominal cavity should be cleaned by thorough irrigation with normal saline.
13. The abdominal cavity should preferably be closed *with a continuous suture including peritoneum and fascia*. The skin should then be closed by a separate continuous suture. If the abdominal cavity has been severely contaminated, the skin and subcutaneous tissues of the laparotomy wound should be left open for delayed primary closure.
14. Excise all missile wounds after the abdomen has been closed and leave them open for later delayed primary closure.

FIGURE 2

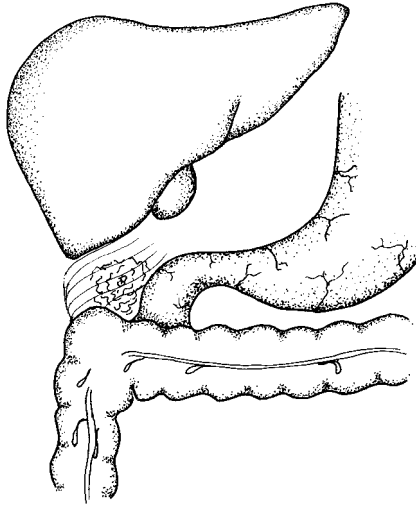

Blood and bile staining in the triangle between the colon and the duodenum suggest a retroperitoneal pancreatic and/or duodenal lesion. Emphysema is suggestive of a colonic injury.

STOMACH

The stomach is injured in 10-15% of abdominal wounds. Single lesions are not common but easily dealt with because of the rich vascularization of the organ. Injury of the stomach is often associated with lesions of adjacent organs: the liver, spleen, colon, pancreas, duodenum, great vessels and kidney, resulting in a high mortality rate. Lesions of the posterior surface may be the only lesion in patients wounded from behind.

If a lesion is found at the anterior surface, a posterior lesion must be suspected and the posterior wall of the stomach inspected.

Wounds of the body should be closed in layers.

Any repair leaving a narrowed lumen in the antrum or the pyloric region requires an associated gastro-enterostomy (Figure 3). Occasionally, a partial gastric resection will be required because of extensive damage.

DUODENUM

Injuries of the duodenum are usually associated with lesions of other major visceral structures, namely the inferior vena cava, the colon, liver, stomach and pancreas. One half of the injuries occur in the second part of the duodenum.

The duodenum is visualized by a Kocher manoeuvre (Figure 1) and by carefully incising the omentum of the transverse colon.

Minor wounds can be closed by suture in two layers at a right angle to the duodenal axis.

Wider wounds needing excision can be closed with a jejunal loop patch. The duodenum is by-passed by a retrocolic gastro-jejunosomy and a tube gastrostomy can be inserted (Figure 3).

FIGURE 3

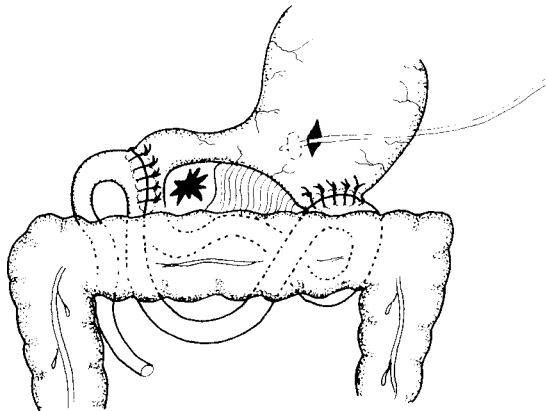

A laceration of the second part of the duodenum can be reinforced by a jejunal loop. The duodenum is decompressed by gastro-jejunosomy and tube gastrostomy. Both anastomoses are retrocolic.

When the injury is more extensive, a partial gastrectomy may be required (Figure 4). The duodenum must be decompressed by a nasogastric tube or by tube gastrostomy (Foley's catheter). The area should be generously drained with corrugated rubber drains, tube drains, or a sump drain (Figure 5).

FIGURE 4

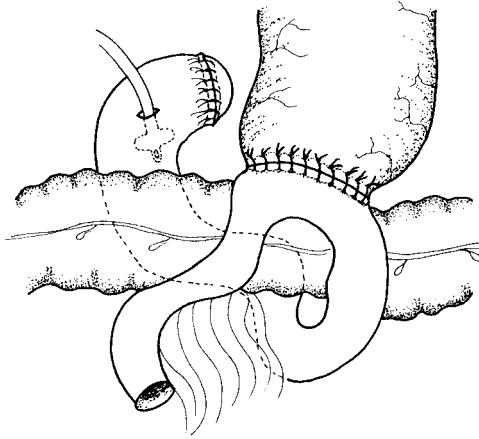

Duodenal decompression by tube duodenostomy (or gastrostomy) with associated gastrectomy.

SMALL BOWEL

Injuries to the small bowel are present in about 30% of penetrating abdominal wounds and are often multiple. Perforations may be small and sealed off by protruding mucous membrane. The only evidence of perforation at laparotomy may be a small amount of blood without intestinal content. If the injury is old, it might be covered by fibrin and omentum.

The principles of treatment are as follows. The small bowel must be inspected carefully throughout its entire length before making any final decision as to repair or resection. Time can be saved if lesions are marked with forceps or a suture when discovered. To prevent leakage, small perforations can be covered by a single suture. Bowel clamps should be applied if there is major destruction. Small perforations can be closed by suture in one or two layers. Bigger perforations might need excision of edges before suturing. Small bowel resection will be necessary when:

- there is major disruption of the lumen;
- there are multiple small perforations over a short area;
- there is disruption on the mesenteric border; or
- the blood supply to a segment has been compromised.

FIGURE 5

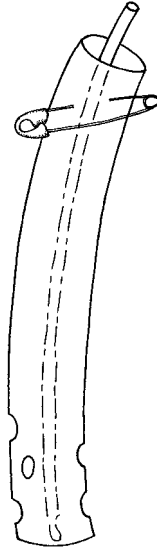

Sump drainage. A thin nasogastric tube is inserted through a larger round tube with multiple perforations distally. The nasogastric tube should not extend beyond the larger tube. The nasogastric tube is fixed to the larger tube and the larger tube is sutured to the patient. If the nasogastric tube becomes obstructed it can be easily replaced, leaving the larger outer tube in situ.

COLON

The colon is the second most frequently injured organ as a result of penetrating abdominal trauma. Injuries to additional structures are common (75-80%) and influence the management and prognosis.

The diagnosis is usually not evident until laparotomy; however, *blood on the examining finger after rectal examination is diagnostic*. Proctosigmoidoscopy is then indicated but often reveals nothing but blood and stool as the rectum is unprepared. Barium enema is *not* indicated.

Colonic injuries are usually serious because the blood supply to the damaged segment is often compromised. The contamination of the peritoneal cavity by faecal material increases the risks, and

anaerobic infections of the retroperitoneum are highly dangerous and often fatal.

The mortality of colonic injuries is seldom less than 15% in war surgery, even in the best conditions.

There may be very little evidence of colonic injury. Suspicion should be increased if:

- there is a *faecal smell*;
- there is *retroperitoneal haemorrhage, especially associated with retroperitoneal surgical emphysema*.

In such cases, the entire colon must be mobilized by division of the lateral peritoneal reflections and the exposed retroperitoneal areas inspected.

Treatment

Colonic wounds can be managed by:

- suture repair;
- exteriorization of the damaged colon;
- resection of the damaged colon with anastomosis;
- resection with colostomy and distal mucous fistula.

Colonic anastomoses, as with all intestinal anastomoses, should not be under tension and should be accompanied by adequate mobilization.

A colostomy or ileostomy proximal to the site of repair has been the rule in war surgery, but the ICRC's working experience has shown that it is rarely necessary. This is supported in the modern literature. A colostomy might be difficult for the patient to accept for cultural reasons, and in many countries colostomy bags will not be available. Therefore, the decision to perform a colostomy must be thoroughly considered. It must never be a routine procedure.

Stomas should not be brought to the surface through incisions. A separate opening should be created.

When a proximal colostomy or ileostomy plus a distal mucous fistula are constructed, they should if possible be adjacent to each other to facilitate later closure.

Large dependent drains are placed in the paracolic gutters by most surgeons when there is extensive faecal contamination of the abdominal cavity.

Right colon

- (a) Wounds of the right colon can be treated with primary suture in two layers.
- (b) If there is a big disruption, resection of the damaged colon and primary end-to-end ileo-transverse colostomy anastomosis is acceptable. If direct anastomosis is considered to present too high a risk in the circumstances, an alternative such as Muir's procedure can be utilized (Figure 6).

FIGURE 6

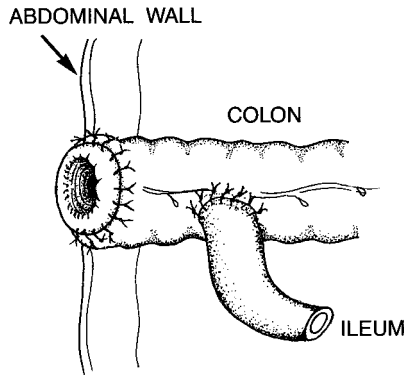

Muir's colostomy.

- (c) In *extensive* right-sided colonic injuries, with associated lesions of adjacent organs, it might be necessary to perform a resection of the right colon with an ileostomy and a distal mucous fistula.

Transverse colon

- (a) Small lesions should be treated by suture.
- (b) Extensive injuries should be treated with resection of the segment involved. If primary anastomosis is not possible, a proximal colostomy and distal mucous fistula should be constructed.

Left colon

The left colon can easily be exteriorized, but *adequate mobilization is mandatory.*

- (a) Small lesions of the left colon should be closed.
- (b) In extensive injuries of the left colon, the damaged segment should be resected and the proximal end brought to the surface as a colostomy. The distal end should be exteriorized as a mucous fistula. The stomas should be adjacent to each other, thus facilitating closure at a later date.
- (c) In extensive lower colonic lesions, it may be necessary to resect the damaged bowel and perform Hartmann's procedure, that is, taking the proximal part out as a colostomy and closing the distal part under the pelvic peritoneum (Figure 7). If possible, the distal colon should be emptied of its faecal content by irrigation – from above to below – before closing the abdomen. *Anal dilatation* is performed at the conclusion of surgery.

FIGURE 7

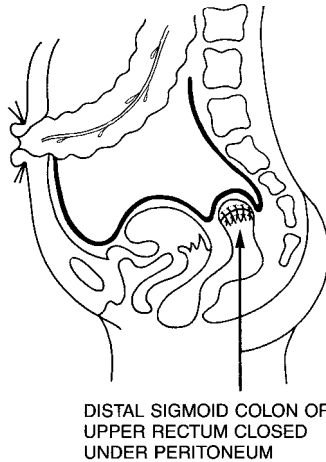

Hartmann's procedure.

RECTUM AND ANAL CANAL

Wounds of the rectum are associated with high morbidity because of the high incidence of unrecognized injury and the common associated visceral damage to adjacent structures such as the bladder, urethra, pelvis and great vessels. Suspicion should be increased if a wound involves the perineum or the buttocks, or if rectal bleeding occurs.

Colostomy is mandatory in rectal injuries.

Treatment includes:

- closure of the rectal wound, if possible;
- defunctioning proximal colostomy either by a double-loop sigmoidostomy or by dividing the sigmoid and bringing out the ends as a separate colostomy and mucous fistula;
- faecal evacuation by irrigation of the bowel distal to the colostomy, at the time of surgery;
- anal dilatation;
- adequate drainage.

Extra-peritoneal wounds of the rectum are managed as above. However, drainage should be dependant and through the presacral space. Removal of the coccyx may be necessary to facilitate the placement of a large drain (Figure 8).

FIGURE 8

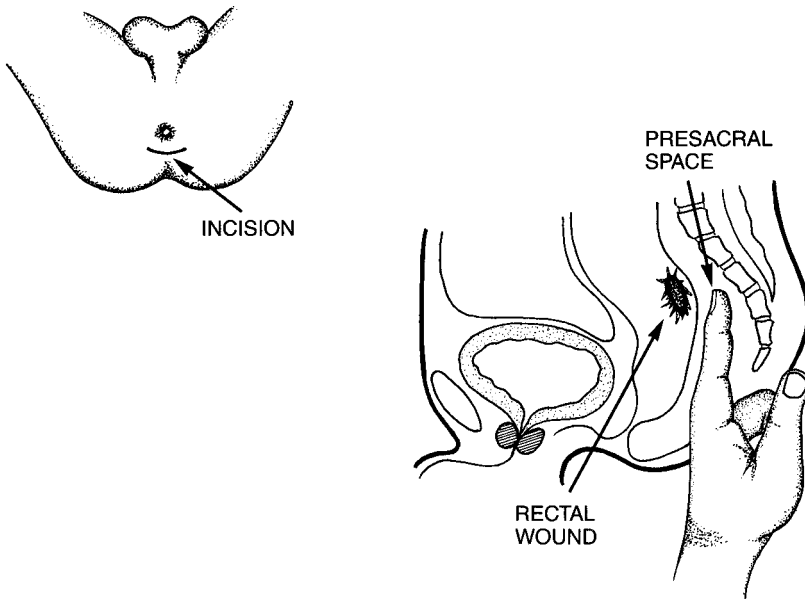

Presacral drainage of an extra-peritoneal rectal lesion. Transverse incision posterior to the anus. Removal of the coccyx may be helpful.

COLOSTOMY CLOSURE

Patients with minor injuries and uncomplicated recovery can normally have colostomy closure performed in *four to six weeks*.

When the postoperative course is complicated by ileus, peritonitis, fistulas or intra-abdominal infection, the closure must be postponed for as long as it takes the patient to recover fully and regain weight. This might be as long as several months.

While closing a double-loop colostomy can be an easy procedure, connecting a proximal colostomy with a distal mucous fistula is a major operation which can be difficult and time-consuming even for experienced surgeons.

LIVER

Hepatic injuries are present in about 5% of abdominal wounds. In most cases, there are injuries to other abdominal viscera.

Liver tissue is particularly susceptible to the cavitation effect of the energy transmitted by missiles with high velocity. These missiles cause extensive pulping of the liver substance and are almost always fatal.

The major cause of death in liver wounds is uncontrollable haemorrhage. However, in about 50% of cases, active bleeding will have ceased by the time of operation.

Treatment

A *midline laparotomy incision* extending superiorly to the sternum, with excision of the xiphoid if necessary, usually gives adequate access. If control of the inferior vena cava, above the liver, is required the incision will have to be extended into the right chest. The ligamentum teres, falciform and coronary ligaments are divided to give access to the upper surface of the liver.

Missiles carrying low energy may cause little more than a slowly oozing cavity through the liver parenchyma. Treatment consists of abdominal toilet and external *drainage* through a generous posterior flank stab incision.

In more extensive wounds with deep lacerations and moderate to heavy haemorrhage, local packing and *compression of the hepatic artery and portal vein* in the free edge of the gastro-hepatic omentum using fingers or soft tissue clamp for 10-15 minutes (Figure 9)

may control haemorrhage sufficiently to allow haemostasis to be effected. Occluding the gastro-hepatic omentum intermittently will reduce the possibility of hepatic anoxia.

When haemorrhage is not controlled by this manoeuvre, damage of the hepatic veins is likely. In these cases, control of the inferior vena cava above and below the liver, and of the aorta, is necessary.

FIGURE 9

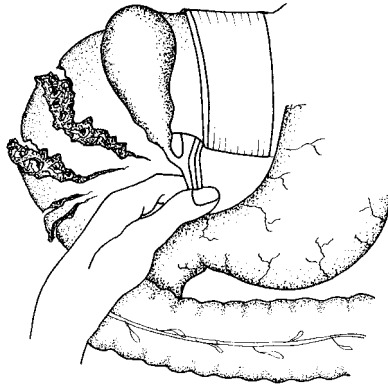

Compression of the portal vein and hepatic artery in the free edge of the gastro-hepatic omentum (Pringle's manoeuvre).

When pressure and local ligation of the bleeding points fails to control haemorrhage, *occlusion of the common hepatic artery* in the porta hepatis should be attempted. If haemorrhage is controlled, individual occlusion of the right and left hepatic arteries may localize one or other as the feeding vessel and this can be ligated. If control is obtained only by common hepatic artery occlusion, this is ligated. Ligation of a hepatic artery, especially the common hepatic artery, is associated with high mortality and should be avoided unless the situation is desperate.

Following excision of nonviable hepatic tissue and ligation of bleeding points, further haemostasis is effected by inserting full thickness *mattress sutures* through the liver parenchyma.

Occasionally, *lobar or sublobar resection* of liver substance is necessary to control haemorrhage. After incision of the liver capsule, the devitalized parenchyma is broken through with blunt fin-

ger dissection (finger fracture excision). Major blood vessels and biliary radicles are ligated individually. The resulting raw surface should be compressed with a series of mattress sutures (Figure 10).

FIGURE 10

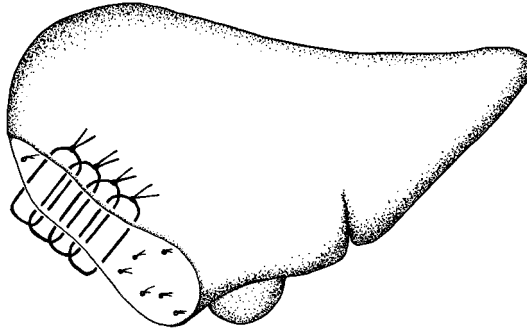

Partial resection of the liver, illustrating individual ligation of vessels and biliary radicles, and haemostatic liver sutures.

If all these measures fail to control haemorrhage, *packing* should be used. The packing should be removed at a second operation two or three days later. Packing may be used to control haemorrhage when mass casualties make prolonged surgery impossible.

Drains, multiple if necessary, either corrugated or tube, should be brought out posteriorly through the right flank. T-tube drainage of the common bile duct is indicated only when there is an injury to the biliary ducts. It is not necessary for liver injuries. Biliary ooze from the resected surface should rapidly subside.

Complications

Complications include secondary haemorrhage, subphrenic, intrahepatic or subhepatic infection and biliary fistulas. Complications are usually caused by inadequate excision of devitalized parenchyma, or unrecognized associated injuries to other abdominal organs, especially the colon. When a major liver resection has been performed there is nearly always postoperative *jaundice*. This resolves spontaneously after 8 to 10 days.

SPLEEN

Injuries of the spleen should be treated by splenectomy.

Injuries to the spleen from missiles are rarely isolated and should be treated by splenectomy. This is the only safe treatment. Repair is not appropriate where there is no adequate postoperative care and limited supplies of blood.

Lateral extension of the abdominal incision may be necessary if the spleen is very large (which is often the case in tropical areas).

Splenic vessels should be ligated close to the spleen to avoid damage to the pancreas. The artery and vein should be ligated separately. Care must be taken to avoid ligating the stomach wall when dealing with the short gastric vessels. *The subphrenic space should always be drained*, as subphrenic infection is the most common complication following splenectomy.

PANCREAS

Pancreatic lesions are present in 1%-2% of all intra-abdominal injuries.

The pancreas must be carefully inspected in its entirety. This requires incision of the gastrocolic omentum and mobilization of the head and tail of the organ so that the posterior surface can be visualized. The inferior margin is inspected by incising the transverse mesocolon.

Many wounds of the pancreas are associated with major vascular damage.

Treatment

The principles of treatment are: haemostasis, excision of dead tissue and drainage of the pancreatic fluid.

Minor injuries, with an intact pancreatic duct, are adequately treated only with dependent *drainage* through the posterior flank via a large tube. If a suction pump is available, sump drainage,

using a nasogastric tube placed through a large-bore round tube, is helpful (Figure 5).

In major injuries to the pancreatic tail, *distal resection* – which will generally include the spleen – is performed. After meticulous haemostasis, the pancreatic duct is ligated and the resected surface is closed with mattress sutures (Figure 11). Adequate drainage is vital.

Lesions of the pancreatic head are treated by haemostasis and drainage. *Pancreato-duodenal resection should not be attempted.*

Complications

Complications include fistulas, pancreatitis and pseudocysts. Careful observation is important and reoperation to remove necrotic tissue and control pancreatic duct leakage may be necessary.

Adequate drainage is vital in pancreatic injuries.

FIGURE 11

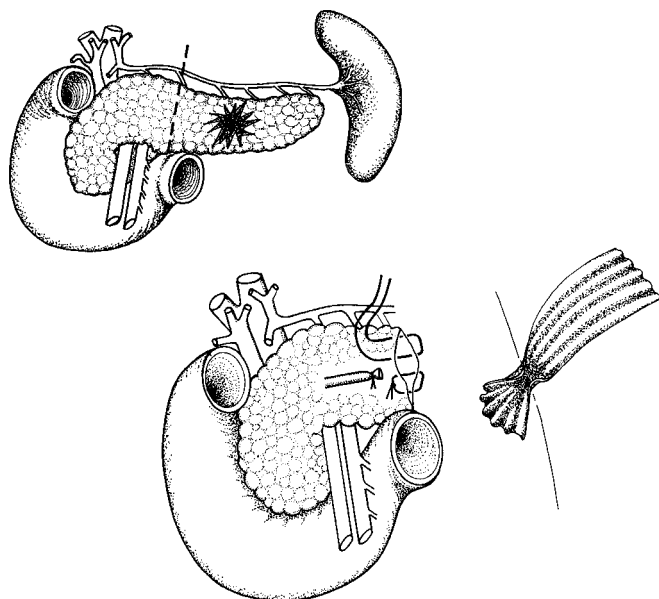

Injuries to the pancreatic tail.

GREAT VESSELS

Lesions of the great vessels are usually fatal. They usually present at operation as a retroperitoneal haematoma.

Access to the proximal aortic area is obtained by reflecting the right colon and the duodenum via an incision in the right paracolic gutter and a Kocher manoeuvre. Access to the infrarenal part of aorta and inferior vena cava is easier, by mobilizing the small bowel toward the right side of the patient. Haemorrhage should be controlled by compression until a partial occluding vascular clamp is placed, allowing suture, resection or patching.

PELVIC FRACTURES

Pelvic fractures are normally of minor importance unless the fracture is unstable. Displacement of the fragments seldom needs reduction. Fractures of the pelvic ring require immobilization for eight to twelve weeks.

A canvas sling suspended by crossed wires from a beam is usually sufficient. External fixation is a possibility if the fracture is unstable.

The major problem with pelvic wounds is bone fragments which penetrate the pelvis viscera and veins. Profuse oozing from the veins and cancellous bone can often be treated by packing alone.

POSTOPERATIVE CARE

Nutrition

As a general rule, nasogastric tubes should be removed as soon as possible and intake of fluids and food by mouth started. If there are no injuries to the stomach or small bowel, this can be done the day after the operation. When these organs have been injured, most surgeons will wait until there are clear bowel movements. Some water by mouth can, however, be allowed for these patients.

Intravenous feeding with amino acids or fat solutions is rarely possible in war conditions but enteral feeding through the nasogastric tube should not be forgotten.

Drains

Large-bore tube drains, with several side holes, and/or corrugated rubber drains can be used. They should be brought out through *separate dependent incisions*.

Drains should be dependent.

If suction is available, sump drainage is useful when dependent drainage is not possible. A large-bore rubber tube with lower side holes is provided with a thinner inner tube to which suction is connected. The inner tube has one hole close to the distal end (Figure 5). Gentle suction is applied. This method of suction drainage can be used in any part of the peritoneal cavity where pus or fluid may collect.

Drains should be removed as soon as possible to avoid infection entering through the drain into the peritoneal cavity. Most drains can be removed after 24 hours.

Urinary catheter

A urinary catheter put in for monitoring during the operation should be removed as soon as possible, to avoid infection. In severely dehydrated cases, however, it is wise to keep the catheter for monitoring the fluid balance. In most cases, the catheter can be removed after 24 hours.

After bladder injuries, the catheter should be kept for a week (chapter 13).

Abdominal wounds

Laparotomy incision

If dressings are dry, there is no need to change them until the time for removal of the sutures. If dressings are soaked by blood or pus, the wound must be inspected. If bleeding is continuing, it should be stopped by compression or an extra stitch. Sometimes, the wound has to be opened to find the bleeding spot. If there is pus around the sutures, they should be removed.

Excised wound

Dressings should be left undisturbed until the day of delayed primary closure.

Physiotherapy

Early mobilization of patients is important to avoid complications such as pneumonia, thrombosis, stiffness of joints and wasting of muscles. Skilled staff are needed who understand the importance of getting the patient out of bed, because most patients certainly prefer to stay inactive after major operations such as laparotomies.

Painkillers

In a war situation, the demand for painkillers is not as pressing as in civilian practice. Most patients seem to accept the situation and some are just happy to be alive. After major operations such as laparotomies, there will be a need for painkillers as injections for at least 24 hours. In many countries, it is very difficult or impossible to get permission to bring in narcotics, so the choice of painkillers is limited. Suppositories are rarely accepted for cultural reasons and might be difficult to store in a hot climate.

POSTOPERATIVE COMPLICATIONS

Fever

Fever can result from all well-known causes, such as urinary tract infection, atelectases, pneumonia, thrombosis and wound infection, which are treated as elsewhere. Intra-abdominal abscesses might be difficult to find in the absence of ultrasound but if there is fever and a palpable tender mass, drainage is necessary. In countries where malaria is endemic, fever 48 hours after an operation usually means that the patient has malaria. Even if a first malaria smear is negative, it may be wise to start malaria treatment.

Abdominal dehiscence

Dehiscence should be treated by immediate laparotomy and mass closure.

Fistulas

Small bowel fistulas and biliary fistulas will heal if there is no distal obstruction. Conservative treatment, including correction of nutritional deficiencies such as anaemia, should be tried. But if the amounts coming through the fistula are big or increasing, an operative intervention is necessary. Most importantly, an abscess causing distal obstruction must be drained.

Peritonitis

Peritonitis with deteriorating condition of the patient after war injuries is often the result of a perforation that was not found during the first laparotomy. Relaparotomy in these cases carries a high risk of mortality (50% according to some authors). If the cause is a leaking bowel anastomosis, the anastomosis area might be exteriorized or, if this is not possible, repaired with a proximal colostomy or ileostomy.

Postoperative intra-abdominal bleeding

Since blood for transfusion is often scarce in war, relaparotomies to stop bleeding should be performed without too long a delay.

13. URO-GENITAL LESIONS

Wounds of the uro-genital system are not common, occurring in only 1-2% of the wounded..

Management of uro-genital injuries is similar to that for other wounds and includes:

- wound excision;
- dependent drainage;
- diversion of the urinary flow above the injury.

Kidney damage must always be suspected after blunt trauma to the lumbar region. This will be confirmed if haematuria develops. Surgery is only indicated if severe macroscopic haematuria persists over 48 hours and/or the patient becomes shocked as a result of blood loss. Delayed haemorrhage up to 2 weeks after blunt trauma is possible.

Bladder injury is suspected, but not proven, if the passage of a catheter does not produce urine. Other possibilities are that the patient is anuric or that there is a rupture of the posterior urethra and the catheter has not entered the bladder. But up to 300 ml of urine may be retrieved by a catheter in a bladder with small perforations, and even intraperitoneal bladder perforations may drain 100-200 ml of urine.

If a *urethral injury* is suspected, a catheter must *not* be passed before surgery as there is a risk that a partial laceration of the urethra may be worsened.

Suspicious signs of a urethral injury are an inability to pass urine, bleeding via the urethral orifice and wounds indicating that a missile has damaged the urethra. Difficulty in passing a urethral catheter always raises the possibility of a urethral injury. If an injury of the urethra is suspected, a rectal examination should be performed.

After the operation, a urine flow of at least 1000 ml/24 hours is required to prevent catheter encrustation and infection, and to decrease the need for irrigation.

A thin bladder catheter (ch. 14-16) is preferred, except when haematuria is expected.

When an indwelling catheter is used in males, the penoscrotal angulation is reduced by fixing the penis to the abdominal wall with adhesive tape. In females, the catheter should be taped to the anterior thigh (Figure 1).

To prevent ascending infection, cleaning around the catheter with an antiseptic should be performed twice daily.

FIGURE 1

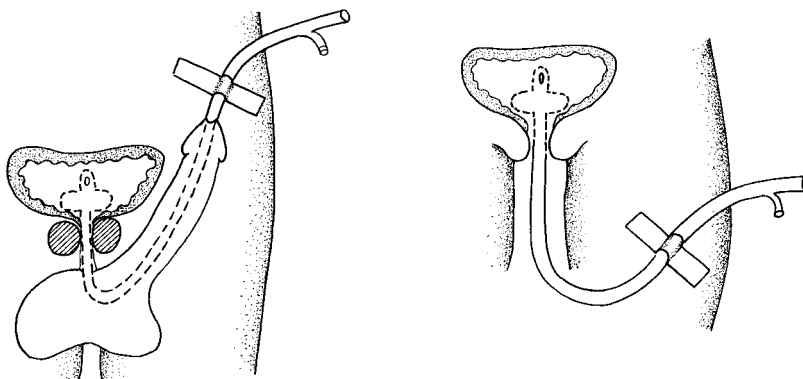

Indwelling catheters in men are taped to the abdomen, in women to the thigh, to prevent pressure on the urethral mucosa.

KIDNEY

Isolated penetrating lesions of the kidney are *very rare*.

Operation through a long median incision gives excellent access to the kidney. Following incision of the paracolic peritoneum, the colon is mobilized and the kidneys are exposed.

When a perirenal haematoma is encountered, the perirenal fascia should not be opened before the renal vessels have been

exposed and vascular clamps are available. Releasing the tamponade provided by the perirenal fascia may result in massive haemorrhage and an unnecessary nephrectomy.

Never open the perirenal fascia over a haematoma without first exposing the renal vessels.

Nephrectomy

Nephrectomy is sometimes necessary to achieve haemostasis.

Indications for nephrectomy are:

- avulsed kidney;
- damage to the vascular pedicle;
- uncontrollable haemorrhage.

When nephrectomy is performed, the vessels should be doubly ligated, preferably ligating the vein and artery separately, and always ligating the artery first. The ureter should be divided and the distal end ligated.

Partial nephrectomy

Partial nephrectomy is indicated *only* when the injured kidney is the patient's only kidney.

The vascular pedicle should be controlled and the artery to the damaged part of the kidney should be divided. Non-viable tissue should be removed by the finger-fracture method, and bleeding vessels should be ligated. The pelvis and calyces should be closed by interrupted sutures. The resected surface should be compressed with interrupted mattress sutures. In cases of doubtful haemostasis, a fascial or muscle patch may be sutured to the resected surface. A nephrostomy tube should be inserted before closure of the renal pelvis (Figure 2).

A large drain, placed through a dependent incision, drains the vascular stump and the resected surface. The drain should not be removed until drainage has ceased.

The surgeon must always ensure, by intra-abdominal palpation, the existence of a second kidney. If a second kidney cannot be found, partial resection must be performed, if possible. Normal renal function can be achieved with only one-third of a kidney intact.

FIGURE 2

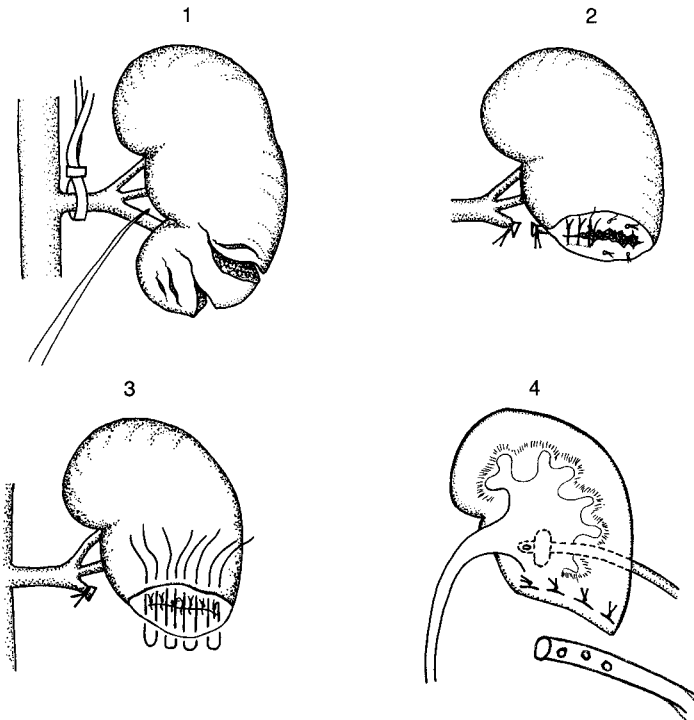

Partial nephrectomy:

- (1) The artery to the damaged part of the kidney is divided.
- (2) Resection is performed by finger-fracture; vessels are sutured and the pelvis closed with interrupted sutures.
- (3) The resected surface is compressed with mattress sutures.
- (4) The urinary flow is drained by means of nephrostomy, and the kidney bed is drained externally.

URETER

Isolated injuries of the ureter are very rare.

In complete ureteric division, the ends are trimmed and anastomosed end to end with fine absorbable sutures over a ureteric catheter, with the ends obliquely cut or spatulated (Figure 3). A watertight closure is preferable but not necessary.

Diversion of urine is achieved by nephrostomy, pyelostomy, or a ureteric catheter (Figure 4).

Dependent external drainage of the anastomosis is essential.

In larger defects in the middle or upper end of the ureter, where the ends cannot be satisfactorily mobilized – that is, up to 5 cm – it is sometimes possible to mobilize the kidney distally. If not, nephrectomy is indicated.

FIGURE 3

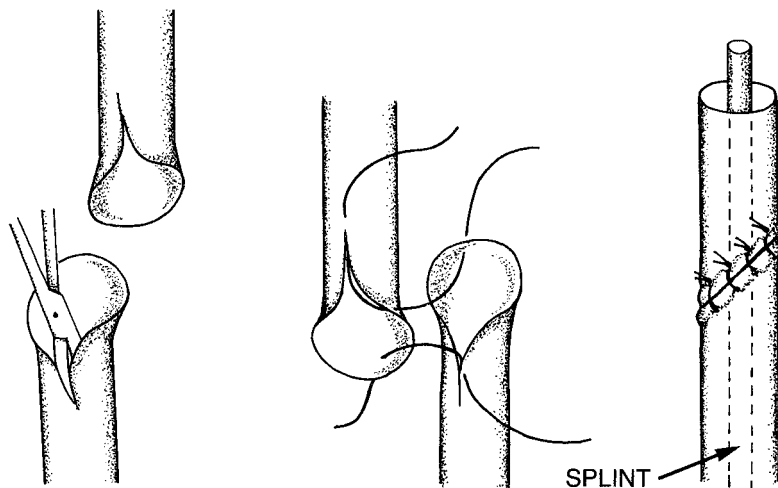

After resecting the damaged part of the ureter, the ends are spatulated and united with thin interrupted sutures.

FIGURE 4

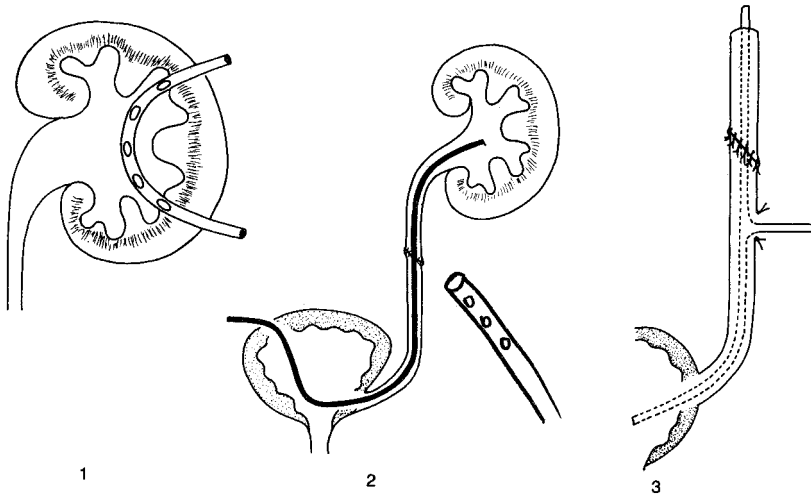

Drainages:

(1) *Ring nephrostomy.*

(2) *Drainage by ureteric catheter. The catheter is passed out through the bladder wall. Dependent external drainage of the anastomosis.*

(3) *Drainage by T-tube.*

In all methods, the catheter is usually kept in for at least a week.

A *distal* ureteric lesion is best treated by reimplantation into the bladder. The anastomosis must not be under tension (Figure 5). If this is not practicable, the ureter should be brought to the surface as a ureterostomy. If this is not possible, then the ureter should be implanted in the contralateral ureter. If none of the above are possible, nephrectomy is the last resort.

FIGURE 5

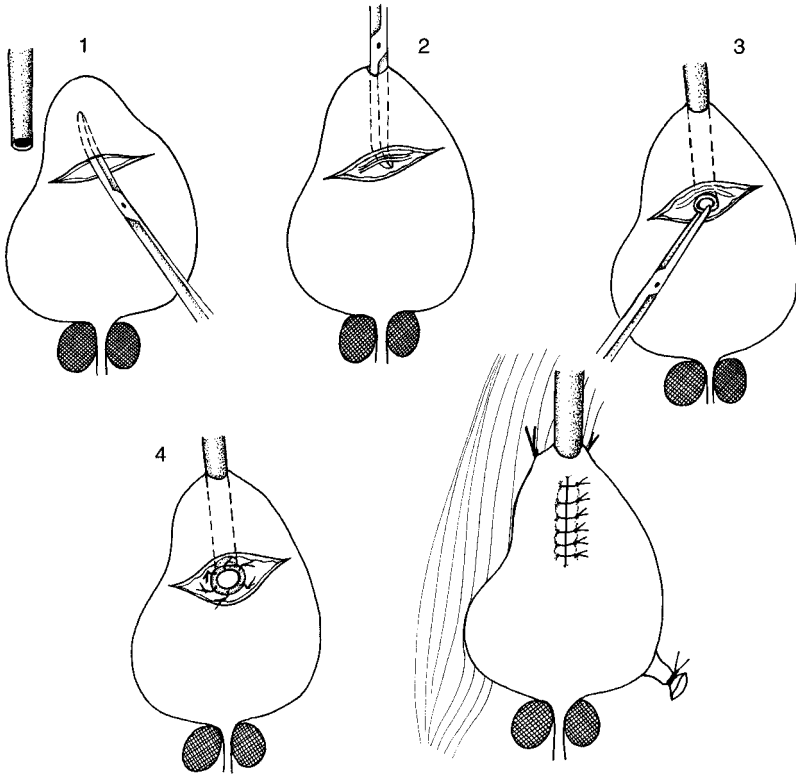

Reimplantation of the ureter in the bladder:

- (1) An incision is made 4 cm below the highest point of the bladder.*
- (2) The ureter is guided through a submucosal tunnel.*
- (3) The ureter is sutured to the bladder mucosa with interrupted absorbable sutures.*
- (4) The top of the bladder is stitched to the psoas muscle.*

Closure at right angles to the incision.

Division of the contralateral vesical pedicle may be necessary to mobilize the bladder.

BLADDER

Bladder lesions may be intra- or extra-peritoneal. Not uncommonly, bladder lesions are not discovered until the catheter balloon is seen in the laparotomy wound.

Minor extra-peritoneal lesions can be treated with an indwelling catheter only for one week.

All other bladder wounds must be excised and sutured in two layers. A large part of the bladder can be resected without subsequent severe capacity problems. The surgeon must be very careful not to compromise the ureteric outflow when the injury is in close proximity to the bladder neck. It may be necessary to reimplant one or both of the ureters. Sometimes it is difficult to identify the ureteric orifices because of laceration or oedema. In these cases ureteric catheterization above the bladder is useful.

An indwelling urethral catheter (Foley 14-16) and a suprapubic catheter (ch. 20-24) should always be used. The latter should be led out through a separate incision 5-6 cm superior to the symphysis. The prevesical space should be drained as long as there is urine coming into the drain. The suprapubic catheter can usually be clamped after 5-7 days and, if there is no leakage of urine, removed the next day. The Foley catheter should then be clamped intermittently (bladder training) and can be removed when the patient can tolerate a clamping of at least 2-3 hours before he feels an urge to micturate.

URETHRA

Principles of treatment:

- Urine should be diverted by suprapubic cystostomy.
- Excise the wound but be careful not to remove the remaining urethra.
- Leave the wound open.
- Inspect at time of delayed primary closure (DPC) and decide whether to:
 - (a) accept permanent urethrostomy;
 - (b) consider late repair (after 6 weeks) if damage is minimal and success can be assured.

Wounds of the anterior urethra, that is the urethra below the urogenital diaphragm, may be closed at right angles to their long axis provided the wound is partial and not more than 2 cm in length. If there has been complete division of the urethra, and provided the separation between the ends following excision is not more than

4 cm, reconstruction by end to end anastomosis, following mobilization of the proximal and distal urethra, is possible (Figure 6). When performing excision and anastomosis, passage of catheters from the penis posteriorly, and the bladder anteriorly, will help identify the structures. The final anastomosis should be splinted by a silicone catheter (ch. 14-18) passed from the penis into the bladder. This should be left in situ for 12-14 days.

If the separation is greater than 4 cm, and anastomosis is not possible, a permanent suprapubic catheter and wound excision is the only alternative available. Elective reconstruction can be performed later – but only by a surgeon trained in these operations.

FIGURE 6

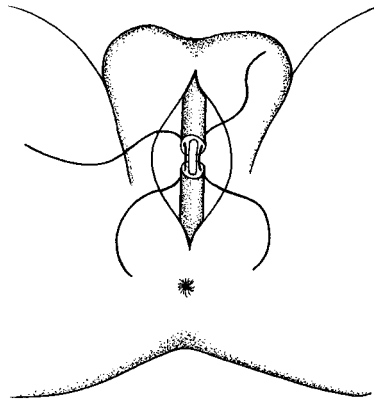

Suture of the perineal part of the anterior urethra. The urethra is closed, after excision, over a (silicone) catheter, ch. 14-18.

Wounds of the posterior urethra, that is the urethra above the uro-genital diaphragm, should be operated on via an abdominal approach (Figure 7).

Suspicion of these injuries is raised when the patient cannot pass urine, and when there is blood in the urethral orifice. Rectal examination often shows nothing more than haematoma and oedema; sometimes a floating prostate can be palpated high in the pelvis. This is always an indication for immediate surgical intervention.

FIGURE 7

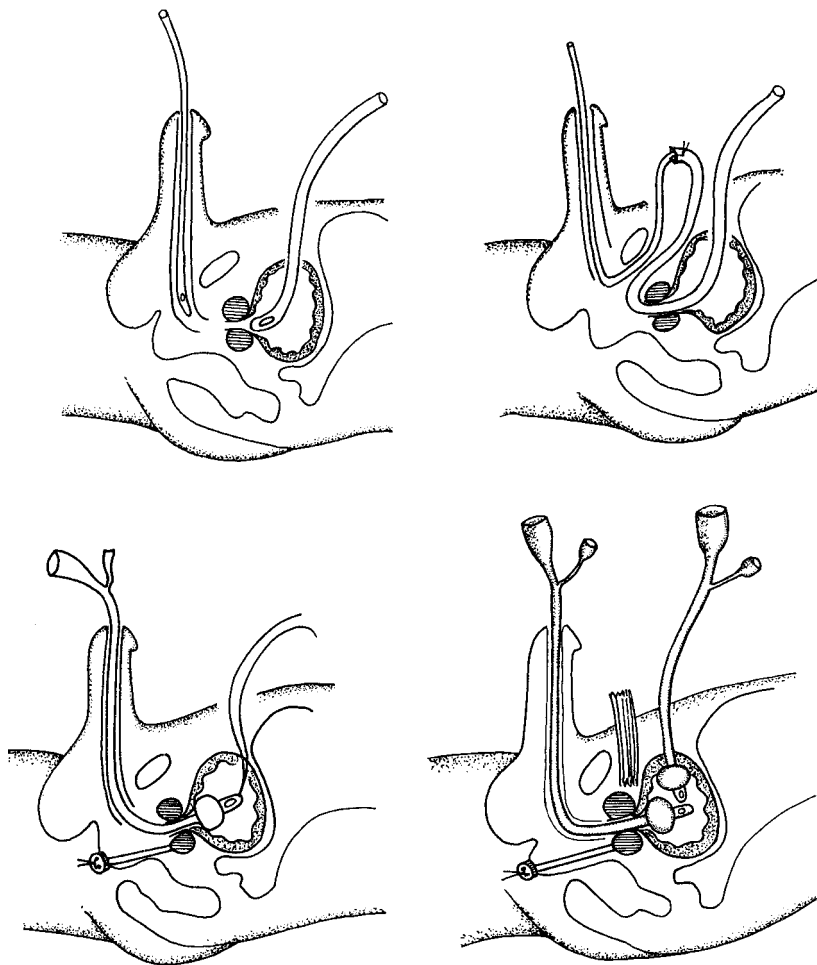

Steps illustrating the "rail roading" procedure utilized for repair of a lesion of the posterior urethra (see text).

A catheter (ch. 16-18) should be inserted distally, and a second, thicker catheter (ch. 20-24) should be passed via the bladder into the wound. The tip of the distal catheter should be placed into the cut-off end of the upper one and secured with a ligature. The catheters should be guided into the bladder. Non-viable tissue must

be excised. Suture of the cut ends of the urethra is not possible. Two stout non-absorbable sutures, passed through the prostate, should be tied over buttons in the perineum and removed after two weeks. This method keeps the ruptured ends together and is preferable to traction on the urethral catheter, as complications may arise because of pressure necrosis at the bladder base.

The tip of the urethral catheter should be tied to a stout non-absorbable thread brought out through the abdominal wall. If the catheter slips out, the thread can be used to guide a new catheter into the bladder past the site of the lesion.

The bladder should be drained via a suprapubic catheter and a prevesical drain. The suprapubic catheter may be removed after one week, the urethral catheter after three weeks.

EXTERNAL GENITALIA

The *external genitalia* can be treated with primary suture after excision, because of the excellent vascularization. The aim is to re-establish anatomical conditions.

The *scrotum* should be drained dependently.

Bilateral *testicular* lesions are very rare. For hormonal reasons, it is important to leave some viable testicular tissue, but the tunica albuginea must always be closed carefully, otherwise a fistula will develop.

When all the *scrotal* skin has been lost but the testes are still viable, they may be covered by placing them under the inguinal or femoral skin.

14. WOUNDS OF THE HEAD AND SPINAL CORD

WOUNDS OF THE HEAD

Most severe penetrating head wounds will be fatal. But a percentage will survive and present a daunting challenge to those with little or no neurosurgical experience. The following principles should be followed.

Emergency care

1. Intubate unconscious patients to protect the airway.
2. Control haemorrhage. Apply clean dressings over large open wounds, including the scalp.
3. Assume that a cervical spine injury is present until proven otherwise. Keep the head and neck in the neutral position.
4. Assume that hypotension is a result of hypovolaemia. Look for a cause of bleeding, such as bleeding into the chest or abdomen, or bleeding from the extremities. Remember that a head injury alone does not produce hypotension except in the late phases of impending brain death.

If the patient is hypotensive, look for an extracranial cause.

5. If there is a penetrating wound or leakage of cerebrospinal fluid (CSF), tetanus vaccine should be given and antibiotics cover with penicillin i.v. 5 million units 6-hourly and chloramphenicol i.v. 1 g 6-hourly.

Clinical assessment

Consciousness

The Glasgow Coma Scale is a simple and useful tool for recording the degree of coma and the changes over time.

<i>Glasgow Coma Scale</i>		
Eye opening response	spontaneous	4
	to voice	3
	to pain	2
	none	1
Best verbal response	oriented	5
	confused	4
	inappropriate words	3
	incomprehensible sounds	2
	none	1
Best motor response	obeys command	6
	localizes pain	5
	withdraws (pain)	4
	flexion (pain)	3
	extension (pain)	2
	none	1
Total score		3-15

Patients with a Glasgow Coma Scale score below 8 will need intubation and ventilation, which is rarely possible in war conditions.

Respiration

An acute rise in intracranial pressure is reflected by a slowing of the respiratory rate. As the intracranial pressure continues to rise, the respiratory rate quickens.

Blood pressure

A rise in intracranial pressure is usually associated with a rise in systolic pressure and a widening of the pulse pressure.

Pulse

Elevations in intracranial pressure produce bradycardia. A rising pulse rate is a grave sign unless it is the result of another cause, such as hypovolaemia.

Temperature

A swinging temperature can be a sign of brain stem damage. Hyperthermia can be treated by cooling of the patient and chlorpromazine 50 mg 6-hourly intramuscularly.

General physical assessment

1. Identify any associated injuries. Examine the whole patient carefully.
2. Note small puncture wounds in the skull. These might be the only indication of a penetrating brain injury.
3. Palpate all lacerations of the scalp. This may be the only way to discover depressed fractures of the skull.
4. Look for peri-orbital ecchymoses which will suggest an orbital roof fracture. Look for bleeding from the ears or haemotympanum which will suggest a temporal fracture.
Look for ecchymoses behind the ears which will suggest a mastoid fracture. Note any fluid (CSF) leaks.

Diagnostic tests (if available)

1. A skull X-ray should be taken in all cases of penetrating injury. Note the location of any foreign body and note its probable course.
2. Chest X-ray any comatose patient to exclude associated thoracic injuries, such as haemothorax or pneumothorax.
3. X-ray the lateral cervical spine. Make sure the shoulders are depressed so that an adequate view of C6 and C7 is obtained. Make sure that good views of all seven cervical vertebrae, and the odontoid process, are obtained.

Surgical intervention

Penetrating missile injuries

These wounds are not treated differently from missile wounds to other areas of the body. The main aim is to remove all dirty and necrotic tissues by thorough wound excision.

- (a) The patient should be placed supine except when there is a posterior fossa injury.
- (b) Non-viable skin and subcutaneous tissues must be excised.
- (c) The damaged bone edges must be removed with bone nibblers.
- (d) Remove all bone fragments, clot and accessible foreign material by careful excision and low pressure suction. The finger can be used as a gentle probe to localize fragments and foreign bodies. *If metallic foreign bodies like shell fragments or bullets are not easily found, they should be left.*
- (e) Establish haemostasis. The use of cautery and hot forceps can be very useful, as well as hydrogen peroxide and bone wax.
- (f) Irrigate the wound with warm saline.
- (g) Repair the dura if possible, otherwise leave it open.
- (h) If there has been skin loss, rotation flaps may have to be employed to gain skin cover.
It is essential to have good skin cover over the area of bone defect.

Depressed skull fractures

If the patient has no symptoms and you are not an experienced neurosurgeon, it might be wise not to operate these cases under war conditions.

If the patient has symptoms of compression and/or he has a penetrating wound that you will operate on anyhow, you should also try to elevate depressed fragments.

Large depressed bone fragments, if removed, should be replaced, as well as any large fragments removed during craniectomy.

Closed intracranial haematoma

These are rare in war surgery but can be seen, for example, after a fall from a tank. Closed head injuries must be closely and repeatedly assessed, and any deterioration in level of consciousness should be an indication to make burr holes (Figure 1). Other signs are development of one-sided weakness or dilated pupil, rising blood pressure and slowing of the pulse. Restlessness and headache can also indicate intracranial haematoma.

Deteriorating consciousness after head injury is an indication to make burr holes.

FIGURE 1

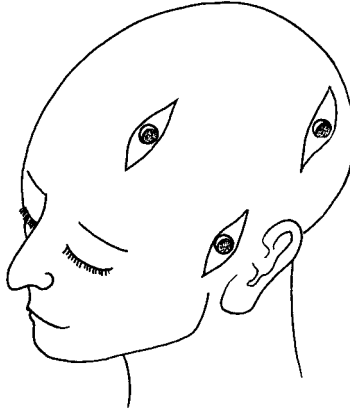

Position of burr holes.

A temporal burr hole, through a 3 cm vertical skin incision, is made 1 cm in front of the ear extending inferiorly from the upper edge of the zygoma. The incision is held open by a self-retaining retractor, which also provides haemostasis. A chisel drill is used to make the initial burr into the skull, followed by a spherical drill to open the bone down to the dura. Bone forceps are used to widen the hole to its desired size.

If a haematoma is not found similar holes are drilled in the frontal region, and finally in the occipitoparietal region.

- (a) Burr holes should be performed with a minimum of delay.
- (b) Make a vertical 3 cm skin incision. Initial burr holes should be placed in the temporal regions over the anterior and posterior branches of the middle meningeal artery on the side of the dilated pupil.
- (c) If no clot is found, a periosteal elevator should be used to explore the local extradural space.
- (d) If no extradural haematoma is found, open the dura to search for a subdural haematoma.
- (e) If no haematoma is found, similar explorations should be made in the frontal and then, if necessary, the occipitoparietal region.

- (f) If no haematoma is found in any of these regions, the same procedure should be repeated on the contralateral side.
- (g) No clot can be adequately evacuated through a burr hole. Thus, if a clot is found, sufficient exposure must be obtained by widening the perforation by bone nibbling. If the access required is large, a bone flap should be fashioned. This will avoid the creation of a large permanent defect.
- (h) Establish haemostasis. Most extradural haematomas originate from a branch of the middle meningeal artery. The artery must be exposed and coagulated. Subdural haematomas typically arise from veins bridging from the cortex to the sagittal sinus, most commonly in the frontal region. These veins must be coagulated.
- (i) Close the dura, if possible, at the completion of the procedure. Drains should not be used beneath the dura.

Postoperative care

1. Continue antibiotic cover with penicillin i.v., 5 million units 6-hourly, and chloramphenicol i.v., 1 g 6-hourly for all penetrating injuries and if leakage of CSF.
2. Elevate the head. This will enhance venous drainage and lower venous pressure.
3. Control body temperature to keep it at a normal or just subnormal level.
4. Restrict fluid intake unless there is a need to treat hypovolaemia. The aim is not to dehydrate the brain, but to prevent overhydration which augments cerebral oedema.
5. Diuretics, such as furosemide 1 mg per kg up to three times per 24 hours, can be used.
6. Anticonvulsants such as phenobarbital (15-30 mg repeated 6-hourly), phenytoin (200 mg 6-hourly) or diazepam (5-10 mg i.m. or i.v.) are only used if the patient has cramps or is excessively restless.
7. Steroids and mannitol have no notable beneficial effect. They are not indicated.
8. Continue regular clinical assessment of level of consciousness. If it deteriorates re-exploration is required, usually to remove a new blood clot.

If level of consciousness deteriorates re-exploration is required.

MAXILLO-FACIAL AND NECK WOUNDS

Wounds of the face can be very complicated and sometimes life-threatening because of the risk of airway obstruction and serious bleeding from areas difficult to access. These are real emergencies and a challenge for both anaesthetist and surgeon.

Emergency treatment

1. Establish airway.

Asphyxia resulting from airway obstruction is the major cause of death from facial injuries.

The portals for air entry can be obstructed by vomitus, blood, foreign bodies and the like. Injuries to the mandible and larynx are the major causes of airway obstruction.

- (a) Remove dentures, broken teeth, blood and mucus from the mouth and throat.
- (b) Nurse the unconscious patient on the side or face down.
- (c) Check the position of the tongue, especially with mandibular fractures.
- (d) Perform endotracheal intubation, where possible. This might be difficult or impossible in unconscious patients with severe maxillo-facial injuries.
- (e) Perform cricothyroidotomy (see chapter 4).

2. Control haemorrhage.

- (a) Apply direct pressure, which will control most bleeding.
- (b) Elevate the head.
- (c) Reduce fractures.
- (d) Perform direct ligation of bleeding points that do not stop with the above measures.
- (e) Packing can be used to supplement ligation of bleeding points. Anterior nasal and maxillary packs should be lubricated with vaseline and removed within 48 hours.
- (f) Epistaxis may sometimes be controlled by Foley catheters introduced through the anterior nares and anchored with gentle traction into the posterior vault (Figure 2).
- (g) Ligation of the ipsilateral external carotid artery is a last resort.

FIGURE 2

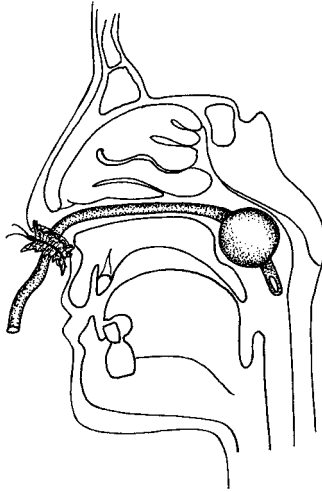

Foley catheter to control epistaxis.

Soft tissue injuries

General treatment

- Wound excision. Primary closure if possible without tension.
- Scrubbing with hard brush to remove superficial tattooing particles.
- Devascularized skin flaps may be excised at the point of demarcation, defatted and replaced as free skin grafts.

Specific localities

Eyebrows. Never shave an eyebrow as it may not regrow.

Lip. Attempt to realign the skin-vermilion junction accurately. The mucosa, muscle and skin should be closed in separate layers.

Tongue. Deep lacerations should be repaired with nonabsorbable sutures.

Eyelid. Closure can be difficult but should be performed in layers making an attempt to approximate precisely the grey line at the

ciliary margin. The canthal ligaments should be repaired and fixed to the orbital wall using nonabsorbable sutures.

Facial nerve. Nerve injuries lateral to the mid-pupillary line should be repaired as a delayed procedure at about six weeks.

Parotid duct. The parotid duct should be left open, because of high risk of parotitis if it is ligated.

Submandibular gland. This should be excised if damaged.

Cheek. Penetrating wounds should be closed in layers if possible (at least buccal mucosa).

Facial fractures

Mandible

Most mandibular fractures will be grossly comminuted. All mandibular fractures should be copiously irrigated. All foreign bodies and loose teeth should be removed but any bone attached to periosteum or muscle with an intact blood supply should be left in situ. Skin and/or mucosa should be used to cover all bone. There are a number of methods available to immobilize mandibular fractures but if the general condition of the patient is bad or there is a lot of bleeding and oedema, final immobilization can wait up to one week. Immobilization is needed for around three weeks.

Vertical bandage: the best method is to use an elastic bandage and fix it to a headcap.

For undislocated mandibular fractures, an elastic bandage is adequate treatment.

Interdental wiring using non-corrosive soft wire: the simplest way to wire the mandible interdentally is to use anchored eyelets, provided there are enough occluding teeth in both jaws for accurate reduction and immobilization (Figure 3). If an emergency develops and the mouth has to be opened, the tie wires can easily be cut with scissors.

Circum-mandibular wires, or upper and lower plastic splints, can be used in toothless patients.

FIGURE 3

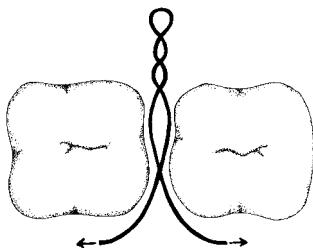

*Eyelets made with soft stainless steel wire.
The wire should be pre-stretched and the eyelets made by twisting about a dental burr.*

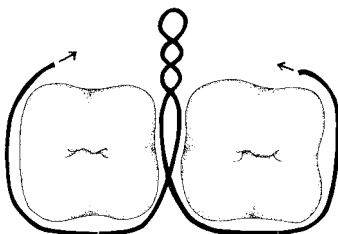

The two ends are passed between two teeth so that the eyelet is on the buccal side.

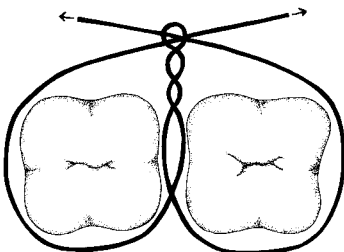

The posterior wire is brought towards the front of the mouth and through the eyelet.

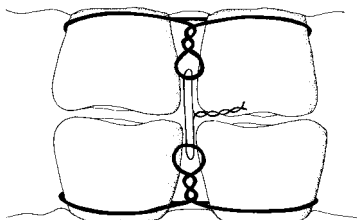

*All twists should be in the same direction.
Tie wires are of thinner gauge than the eyelet wires and join the upper and lower eyelets.*

Internal fixation with wire at the time of delayed primary closure is best used when fractures are unstable because of angulation or muscle pull. A wire is fixed across the fracture by an intra-oral approach. Following fixation, the jaw should be immobilized with a vertical bandage. When placing these wires, an alveolar flap should be raised and holes drilled some 0.5 cm from the fracture sites (Figure 4). If a tooth has been removed from the fracture line, the holes may need only be drilled into the socket, as the outer layer is thick compact bone which gives adequate strength for support. In the symphysis, however, the holes should go through the bone. The fixation wire should only be finally tightened once the teeth are in satisfactory occlusion.

External fixation: the Mini-Set external fixators are a very effective method of immobilizing fractures of the mandible, especially those associated with soft tissue damage (Figure 5). They also have the advantage of allowing mandibular movement and function.

FIGURE 4

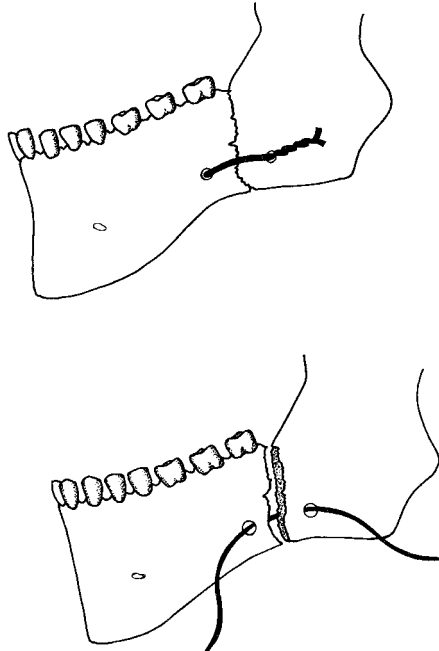

Fixation of mandibular fracture with stainless steel wire pulled through small drill holes.

Maxilla

There is a great variety of maxillary fractures. Often, they are not as complex as they seem. Reduction should be attempted at the time of delayed primary closure. Fractures should be immobilized by means of wiring the fracture site, combined with interdental eyelet wiring as described above, especially if the direct fracture wiring is unstable.

Mini set external fixators placed in the frontal, zygomatic and nasal bones provide excellent stability. Fibrous union occurs rapidly, allowing the fixators to be removed in about three weeks.

If reduction is delayed, fibrous union will have occurred, making reduction impossible without traumatic refracturing of the fracture sites.

FIGURE 5

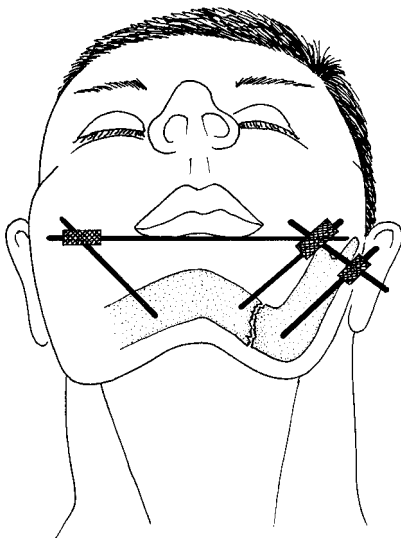

External fixator. Stabilization of fractured mandible.

Fractures involving the floor of the orbit require open reduction and internal interosseous wiring. A semiclosed reduction can, however, be achieved by entering the maxillary sinus through an intra-

oral buccal incision (Figure 6). By keeping the floor of the orbit under vision, it is possible to reduce the fracture by packing with gauze. It is important not to over-reduce the fracture. The gauze can be left in situ for up to three weeks but it must be well lubricated with vaseline. Even so, it might be difficult to remove.

Neck wounds

All neck wounds should be explored to inspect major vessel and main structure integrity.

Oesophageal wounds: small lacerations should be sutured, having excised the edges. It is a good rule to protect the wound for 10-14 days, with either nasogastric tube feeding or gastrostomy. The wound should be left open for delayed primary closure. A large wound of the oesophagus can be converted into a controlled cervical oesophagostomy, or pharyngostomy, and closed at a later time.

FIGURE 6

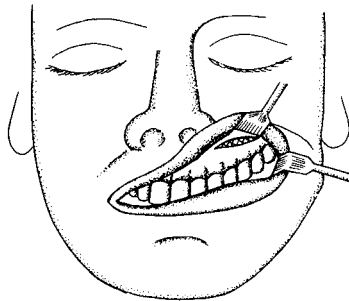

Intra-oral buccal incision for fractures involving the floor of the orbit. An incision is made in the oral mucosa in front of the maxillary sinus above the dental roots. The bone is opened by a chisel.

Larynx and trachea: wounds resulting in a fractured larynx should be managed with a tracheostomy. A small tracheal wound may be used, if it is conveniently sited, for the tracheostomy. If it is possible to close a small tracheal wound, repair should be performed.

Jugular vein: this should be repaired if possible. If not, it should be ligated. If there has been a jugular venous injury, the patient's head should be kept lower than the heart to lessen the possibility of air embolism.

Thoracic duct: if a damaged thoracic duct is encountered at exploration, it should be ligated.

Arterial injuries: beware of an expanding haematoma. This is an indication for exploration.

Any haematoma should be dislodged with caution, as it is probably associated with major vessel damage.

SPINAL CORD INJURIES

The spinal cord can be damaged by missiles either directly, or indirectly as a result of fractures or dislocations. Those with paraplegia are seen more commonly than those with tetraplegia, as the latter will frequently die during the transfer to a field hospital.

Paralysed patients are often low on the evacuation priority list and will reach hospital later than the average.

Wound excision, and the basic principles of wound care, are the same as for all injuries.

Paraplegia

Long-term care must be planned from the outset. In situations where no paraplegic centre is available, the patient and family must be provided with sufficient means to return home and survive in the best possible physical condition.

The major complications to avoid are:

- deterioration of the general condition;
- pressure sores;
- bladder and urinary tract infections.

The following principles apply to the treatment of paraplegic patients of less than 6 weeks duration:

1. Avoid laminectomy unless:
 - (a) there is definite evidence of progressive motor or sensory deficit, and there is radiological evidence of spinal cord compression by a foreign body or bone fragment;
 - (b) there is a persistent CSF fistula;
 - (c) the surgeon feels capable of performing the surgery.
2. In paraplegia caused by fracture or dislocation of vertebrae: use progressive extension when the equipment is available. If extension is impossible, a bi-valve thoraco-pelvic cast is the alternative.
3. Be conscious of the danger of pressure on the iliac crest, scapula and sacrum: the skin over these areas should be checked every 8 hours.
4. If there is no evidence of motor or sensory recovery after 6 weeks, weight bearing may be commenced.
5. Avoid urinary tract infections by good nursing care.

In paraplegia of greater than 6 weeks duration:

1. Assess the extent of the paraplegia.
2. Commence physiotherapy immediately:
 - in bed: sitting, balance exercises, muscle strengthening, respiration, bladder control;
 - standing: posterior plaster splint;
 - gait training: parallel bars, walking frame, simple orthoses.

A spinal cord injury patient requires constant care; one member of the family must be involved in the management from the beginning.

Tetraplegia

The care of tetraplegia in developing countries is an almost impossible task. Thus a realistic approach is to give the patient minimal care, allowing him to live an acceptable life for as long as possible.

Pressure sores

A high proportion of spinal cord injury patients suffer from pressure sores over the sacro-iliac and trochanteric areas, heel and patella prominences.

The *prevention* of pressure sores involves:

- awareness by the hospital staff and the family of the potential problem;
- the immediate involvement of a relative in active preventive management, 24 hours per day;
- the utilization of simple measures to avoid pressure on high risk parts of the skin (Figure 7):

FIGURE 7

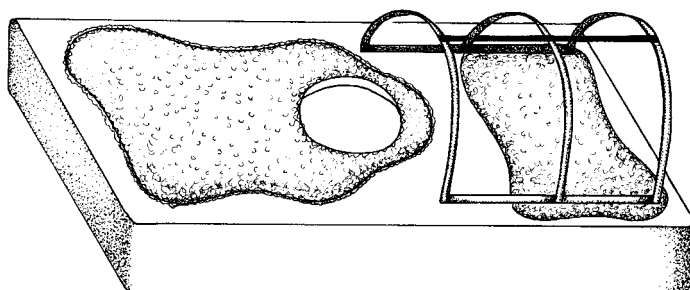

Prevention of pressure sores.

- protective metal arch over the legs and feet to prevent the weight of bedclothes adding pressure to the heels;
- a sheepskin on the bed to protect the buttocks and heels;
- a change in position every two hours, day and night (a simple notice to this effect should be placed over the patient's bed);
- mobilization of the limbs twice daily;
- adopting a standing position as soon as possible.

Pressure sores are avoidable in hospital by vigilant nursing care.

The *treatment* of pressure sores includes:

- no local pressure on the sore;
- position adapted accordingly;
- no sheepskin contact (danger of infection);
- use of a mattress with suitably positioned holes to relieve pressure on the sores;
- sore care:
 - excise necrotic tissue (no anaesthesia needed and this can be done by a trained nurse);
 - for clean wounds: dressing once a day is sufficient;
 - for infected deep wounds: regular change of dressings up to five times per 24 hours will be required;
 - antibiotics are *not* needed, unless there is systemic infection.

Local treatment is as for any wound: excision of all non-viable tissue.

Surgery

Large pressure areas can be very effectively healed by the use of appropriate cutaneous and musculo-cutaneous flaps. No flap should be fashioned before the wound area is clean. This includes removing any osteomyelitic bone. Deep areas of defect will require musculo-cutaneous flaps to obliterate dead space. More superficial defects can be covered by full thickness cutaneous flaps. Split skin grafts should not be used.

Musculo-cutaneous flaps are highly effective, but good nursing care and surgical experience are essential for good results.

Bladder and urinary tract problems

Treatment objectives are:

- prevention of infection;
- prevention of urethral fistulas;
- early removal of urinary catheter, and bladder regulation;
- prevention of epididymitis.

The incidence of infection is lessened by:

- maintaining a fluid input of at least 3 litres a day;
- changing catheters every 10 days if silicone catheters are not available;
- keeping the urine bag below the level of the bladder (Figure 8).

Urethral fistulas are prevented by:

- checking that staff are aware of the non-touch catheterization technique: catheters should not be manipulated once in position;
- correct positioning of the penis: the penis must be attached to the patient's abdomen by two strips of plaster, thus avoiding internal pressure on the peno-scrotal angle.

FIGURE 8

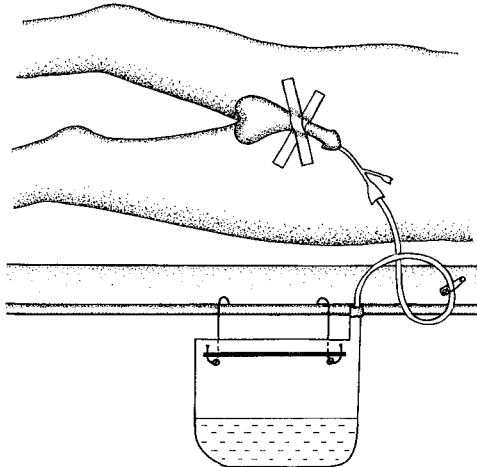

Positioning of catheter and urine bag.

Early removal of the bladder catheter and bladder regulation

One of the causes of infection is the presence of a catheter. The catheter should therefore be removed as early as possible, which is as soon as the spinal shock phase is over (that is, 6-8 weeks after the accident) and the *urine is clear*.

The bladder tone must be determined. This can be done with simple tests that do not require sophisticated apparatus. *The following three tests can be used to determine if the bladder is spastic or flaccid.* These tests will also provide useful information as to the best way to stimulate the bladder to empty.

- (a) *Anal tonus.* The external anal sphincter has the same nerve roots (S2, S4) as the external bladder sphincter. Response to stimulation of the external anal sphincter suggests that the external bladder sphincter has some function.
- (b) *Ice water test.* Introduction of 100 cc of sterile water at 4°C into the bladder with the catheter balloon deflated will give some indication of detrusor muscle function.

If the catheter is ejected: spasticity.

If the catheter remains: flaccidity.

- (c) *Cysto-manometry.* Measuring internal bladder pressure changes in response to stimuli (for example, abdominal or diaphragmatic pressure) to determine the most effective way to empty the bladder (Figures 9 and 10).

Equipment needed:

- one measuring tape;
- one plastic tube 3 m in length (infusion tube);
- sterile water;
- one plastic “Y” piece;
- one clamp;
- one balloon catheter.

FIGURE 9

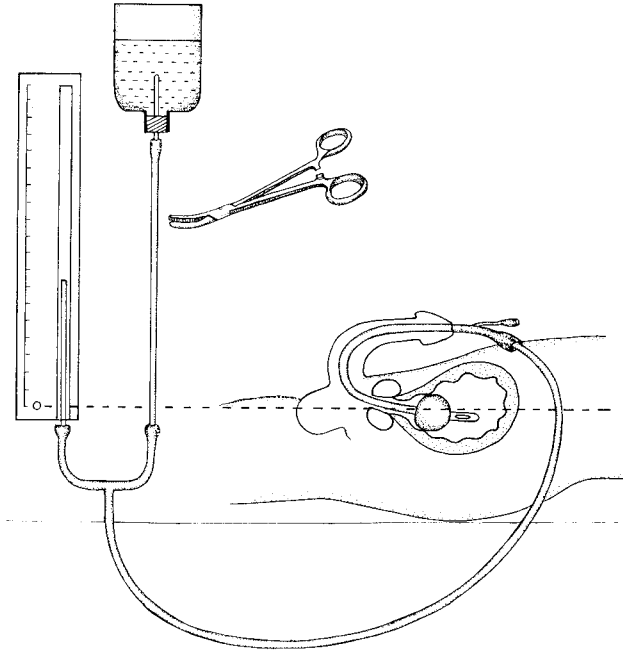

Procedure:

- (a) Fill bladder slowly with 250 cc of sterile water at 37° C. The detrusor muscle must be given time to relax.
- (b) Allow the bladder to relax for 5 minutes.
- (c) Clamp the plastic tube.
- (d) Read the pressure inside the bladder on the measuring tape.
- (e) Record the readings.

When the diagnosis of spastic or flaccid bladder has been established, the patient and the family is taught to empty the bladder by stimulation or pressure. The amount of residual urine is checked every two weeks. The procedure is as follows.

(a) Spastic bladder:

1. Measure the total bladder capacity.
2. Patient drinks 4 glasses of water.
3. *Urination effected by pressure or stimulation.*
4. Measure residual urine.

(b) Flaccid bladder:

1. Measure the total bladder capacity.
2. Patient drinks 4 glasses of water.
3. *Urination by abdominal manual pressure combined with pressure of the diaphragm.*
4. Measure the amount of residual urine.

FIGURE 10

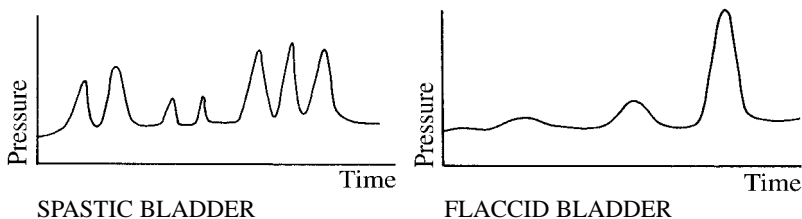

Examples of recordings for a spastic and a flaccid bladder.

The amount of residual urine should not be more than 10% of the total bladder capacity. If this is not so, the tests are to be repeated in 2 weeks. If there is still residual urine, a supra-pubic catheter should be inserted. The tests should be repeated until the residual urine is less than 10% of total bladder capacity.

Once the urine is clear and the appropriate way to empty the bladder has been found, a urine collector should be applied. If ready-made collectors are not available, a normal condom can be adapted to serve the purpose.

Prevention of epididymitis

Epididymitis is a common complication resulting mainly from a prolonged ventral position of the patient and/or late removal of the urinary catheter.

Prevention is best achieved by:

- early removal of the urinary catheter;
- a mattress fashioned so that the penis and the testicles are free from pressure (a 15-20 cm deep hole allows this).

Urinary infection

Urine should be kept acid when a urinary catheter is in place. This can be achieved using ammonium chloride.

In minor infections:

- increase the quantity of fluid drunk (up to 3 litres per day);
- bladder irrigation with a normal sterile saline solution (a total of 1 litre in 200 ml aliquots is effective).

In heavy infections, add antibiotic treatment to the management:

- sulphamethoxazole plus trimethoprim: 2 tabs twice daily (960 mg) for 10 days.

If no response:

- ampicillin: 2 g/day for 10 days.

If no response:

- chloramphenicol: 3 g/day for 3 days, then 1.5 g/day for 7 days.

Equipment needed

The equipment needed for effective paraplegic management is simple and of low cost. Some of it can be manufactured in the hospital workshop and made by local craftsmen:

- condoms (can be bought);
- plastic tubes (from perfusion sets);
- sponge mattress;
- sheepskins;
- standing frames (to be made);
- parallel bars (to be made);
- plaster of Paris bandage (for posterior splint);
- wheelchair;
- crutches;
- simple caliper.

FIGURE 11

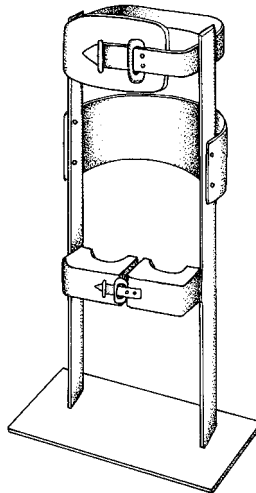

Model of simple standing frame.

15. WOUNDS AND INJURIES OF THE EYE

About 5-10% of all casualties in a war zone have an injury to the eye. Many are isolated injuries to the eye and orbit, but nearly 20% are associated with penetrating wounds of the brain, skull or face. Corneal abrasions, foreign bodies and conjunctival lacerations are very common. About half of all wounds of the eye are penetrating wounds of the globe. The surrounding structures are commonly injured, 25% have eyelid or facial wounds and about the same proportion have fractures of the floor of the orbit.

FIRST AID

The difficult circumstances in a war zone are such that skilled first aid is usually not available.

Basic advice:

- avoid rubbing or squeezing eyes or eyelids;
- close the lid to protect the cornea, if possible;
- apply a clean pad and bandage to cover the eye before evacuation.

EXAMINATION AND DIAGNOSIS

A penetrating ocular injury should be suspected in every wound around the eye and of the upper part of the face.

The preliminary examination should be done with the lids retracted. Voluntary opening of the eyelids will be difficult, and topical anaesthesia with 0.4% oxybuprocaine, 0.25-0.5% cocaine or 0.5% proxymetacaine will be required. Gentle separation using a lid retractor will permit testing of visual acuity and inspection. In the absence of lid retractors, the tips of the fingers should be braced against the bony ring of the orbit before attempting digital separation of the eyelids.

There must be *NO* pressure applied to the globe.

The slightest pressure on a globe which is lacerated or perforated may cause irretrievable loss of the vital contents.

Examination should be done as follows.

1. *Test visual acuity.*

This most important parameter in diagnosing the seriousness of an eye injury should be recorded in five grades:

- reads print;
- counts fingers;
- perception of movements of hand;
- perception of light;
- no perception of light.

In evaluating perception of light, it is important to pass a very bright light in front of the eye whilst completely shielding the other eye from the light and possible heat from the torch.

2. *Inspect lids and lashes for laceration and contusions.*

3. *Inspect the cornea, conjunctiva and sclera with a torch.*

Wash out the conjunctival sac with copious saline or water and pick out any loose foreign material. Topical anaesthetic may be required for this procedure. Inspection of the eye may reveal pupillary irregularity and blood within the anterior chamber (*hyphaema*) or even collapse of the anterior chamber, where loss of aqueous humor causes the iris to come into contact with the posterior surface of the cornea. Lacerations of the cornea or sclera, foreign bodies within the eye or orbit, or disruption of the globe, may be pre-

sent. Gross contamination by dirt and debris frequently accompanies these injuries. Corneal lacerations are usually evident by loss of the anterior chamber and distortion of the pupil. Incarceration or prolapse of the iris through the corneal wounds is common. Lacerations of the sclera usually show darkly pigmented extruded choroid. Small perforating wounds and even quite large scleral lacerations may be obscured by sub-conjunctival haemorrhage. Even more extensive prolapse of intra-ocular contents, such as vitrous humor, uvea, lens or retina, may protrude from any laceration of the globe.

Unless it is obvious that disruption is total, the possibility of salvaging the eye should always be considered.

MANAGEMENT

Ideally, all eye injuries should be treated primarily by an ophthalmologist, even if a considerable delay (up to several days) is involved. In the absence of an ophthalmologist, treatment of major eye injuries in ICRC hospitals has to be the responsibility of the general surgeon.

In this case, measures aimed at *prevention of infection* within the eye should be instituted. Systemic antibiotics, either penicillin, 5-10 units, or chloramphenicol, 1 g, i.v. every 6 hours, should be given together with tetanus prophylaxis. Fractures of the orbital bones should also be treated with systemic antibiotics in order to prevent infection spreading from the paranasal sinuses and causing orbital cellulitis.

Lid and conjunctival debris should be carefully irrigated away using sterile water or saline. This should be followed by generous topical application of a fresh solution of an ophthalmic antibiotic, such as aqueous 1% chloramphenicol, to be instilled every 4 hours together with 1% atropine sulphate drops.

A sterile gauze dressing should be applied to keep the area clean and protected by taping an eye shield over the injured side. *A pressure dressing should be avoided as it may cause serious damage by expressing intra-ocular contents through a penetrating wound.* The gauze dressing should be replaced twice daily and sterile irrigation of mucopurulent secretions from the lid margins

and conjunctivae should be carried out when the dressing is changed. The uninjured eye should be patched to reduce unwanted eye movements.

If the patient can be referred to an ophthalmologist, no eye surgery should be performed. In particular, no attempt should be made to remove protruding, penetrating, foreign bodies or to repair corneo-scleral lacerations.

If the patient cannot be referred, you as a general surgeon should be able to repair injuries to the eyelid, and suture cornea and sclera.

Assessment of injury

An eye is potentially useful so long as it retains perception of light. Gross reduction of vision may result from temporary causes which may clear up. The eye may eventually recover sufficiently to allow some vision. This is a matter of great importance in cases where both eyes are injured.

Any penetrating eye wound is dangerous as it is liable to cause sympathetic ophthalmia.

This is particularly so when the penetrating wound of the globe involves the ciliary region, and especially when complicated by prolapse of the uvea or lens capsule. A retained foreign body associated with a small self-sealing wound may lead to complete disorganization of the eye, but it does not usually give rise to sympathetic ophthalmia, unless it is accompanied by prolapse of the uvea or lens capsule. A suppurating eye rarely gives rise to sympathetic ophthalmia.

The angry red eye or the quiet iridocyclitis indicates the greatest danger.

An eye which has not been perforated does not lead to sympathetic ophthalmia. But a minute perforation may be difficult to detect and is easily missed. Although rare, this complication is a very real threat under difficult circumstances, especially when surgeons are not trained in ophthalmology.

Surgical procedures

Minor injuries

Conjunctival foreign bodies and lacerations

Wash out the conjunctival sac with copious quantities of sterile saline or water, and pick out any loose foreign material. Non-penetrating conjunctival lacerations will heal and 1% chloramphenicol eye drops should be instilled into the conjunctival sac 4 times daily. No pad is required because when the conjunctival sac is closed it is an ideal incubator of organisms.

Corneal foreign body and/or corneal abrasions

Instil two drops of local anaesthetic such as 0.4% oxybuprocaine. If a foreign body is present, remove it with the tip of a large sterile needle, the shaft of the instrument approaching the cornea at a tangent. Scrape out any rust from the ulcer crater that is left after this procedure which will leave a corneal abrasion.

Corneal abrasions may be visualized more easily by the instillation of a couple of drops of fluorescein or a fluorescein strip. Treat the abrasion, whether traumatic or resulting from the removal of a foreign body, with a few drops of a mydriatic, such as 1% homatropine or 1% cyclopentolate, *and* a few drops of antibiotic, such as 1% chloramphenicol. This therapy will reduce the pain from the ciliary spasm, prevent infection and minimize secondary iritis.

Pad the eye. Inspect the abrasion by staining with fluorescein every 24 hours until no further staining of the abrasion occurs, then discontinue the pad. Continue antibiotic drops 3 times daily for a week.

Hyphaema

Blood in the anterior chamber is present in about 15% of eye injuries. Hyphaema occurs with non-penetrating injuries more commonly than with penetrating wounds. The danger of hyphaema is that eyes tend to have a second bleed on the third to fifth day after injury, and the secondary bleed is often worse than the primary bleed, leading to total hyphaema, secondary glaucoma and corneal staining with blood. *This must be prevented by:*

- complete bed rest;
- mydriatic drops, such as 1% homatropine, to prevent the pupil moving;
- chloramphenicol eye drops;
- a pad on both eyes.

Major injuries

Lid lacerations

Repair should be attempted only if fine instruments and suture material are available. The *following basic principles of plastic surgical techniques must be observed:*

- (a) copious irrigation of the wound;
- (b) minimal excision of any dead tissue;
- (c) anatomical apposition of the lid margin in two layers:
 - an initial 5/0 or 6/0 absorbable suture between the lash line and the mucocutaneous junction of the lid margin (the grey line);
 - interrupted 6/0 or 5/0 absorbable suture for the conjunctivotarsal plate, burying the knots when the approach is through the everted lid;
 - interrupted 7/0 or 6/0 absorbable or non-absorbable sutures, using small bites, at the mucocutaneous junction and for the skin.
- (d) if the tissue loss is so extensive as to expose the cornea, temporary cover can be provided by approximating whatever tissue is available; a layer of 1% chloramphenicol ointment should be maintained continuously over any residual exposed cornea.

Corneal wounds

Corneal wounds should be sutured and the anterior chamber reformed.

Magnification of any type will be of great assistance to the operator. *If the laceration involves both cornea and sclera, the cornea should be repaired first.* The finest silk, monofilament or absorbable suture material available (8/0 silk, 6/0 or 7/0 absorbable) and the finest available instruments should be used. The first suture should not be placed until the edges of the wound are carefully aligned. If the laceration involves the limbus (corneo-scleral junction), this should be aligned and sutured first. The cornea should be sutured next and the sclera last. Close attention to the landmarks of the limbus will assist in proper alignment. The curved needle should be introduced almost perpendicularly into the tissues, about 2 mm from the wound edge, and taken to mid-stromal depth from where it should be directed horizontally to the

edge of the wound. The needle should penetrate the other edge of the wound at mid-stromal depth and come out of the cornea 2 mm from the wound edge. The interrupted sutures should be placed every 2 mm. The suture should then be rotated so that the knot is buried in the tissue.

Gaping corneal wounds which cannot be closed by direct corneal suture should be covered by a conjunctival flap. The best technique to use is the total purse-string flap. It is important for the cornea to be circumcised close to the limbus and for undercutting to be extensive so that the flap may be drawn over the cornea without any tension.

Scleral wounds

Scleral wounds should be closed in a similar fashion, using non-coloured sutures.

Gaping scleral wounds should be sutured and protected by a conjunctival flap.

Prolapse of uveal tissue, vitreous or lens capsule

Prolapse should be excised using sharp scissors and the cornea or sclera closed as described above.

Excision of the eye

This should only be done when the globe is completely disorganized by the extent of the damage, usually from extensive corneo-scleral laceration with either prolapse or loss of the intra-ocular contents.

Do not excise the globe completely by cutting the optic nerve, as this can lead to fatal meningitis.

If excision of the eye is indicated at an early stage, complete evisceration of the contents of the eye should be performed. The operation is done as follows.

An incision is made in the sclera, fairly close to its junction with the cornea, and is carried full thickness around the corneo-scleral junction. All the contents of the eye must then be removed.

Gentle curettage will ensure that all the contents have been removed.

The cavity should be packed with a warm saline swab for haemostasis.

Burns

Emergency treatment

Burns in the region of the eye *should not be treated by drying agents or dye preparations*, as this invariably results in extensive ectropion from scar contraction, leading to exposure keratitis, frequently followed by blindness or loss of the eye.

The burnt area of the lid should be thoroughly cleaned with saline, any blister opened and an antibiotic cream applied over the raw area. This should be covered by a vaseline gauze dressing and a pad under a firm bandage. The pad should always be changed before it becomes soaked with exudate, to avoid bacterial contamination.

With exposure treatment of burns of the face, chloramphenicol eye ointment should be applied to the eye 4-hourly and 1% atropine drops twice daily, following irrigation with saline.

Skin grafting

Whole thickness skin burns of the eyelid should be excised and grafted at the earliest possible moment. This gives the best chance of healing and reduces subsequent scarring to a minimum. If this is not done at an early stage, skin grafts should be applied to the raw surfaces of the lids as soon as granulation tissue appears, in order to reduce scarring. If the grafts fail, they should be repeated.

Protection of the cornea

The cornea must be kept covered, if necessary by tarsorrhaphy, during the whole time of healing.

Treatment of complications

Complications, such as traumatic cataract, intra-ocular foreign bodies, detached retina and secondary glaucoma, can only effectively be managed by an ophthalmic surgeon.

16. INJURIES OF THE EAR, NOSE AND THROAT

EAR

The ear may be divided into three parts: the external ear, the middle ear and the inner ear. There are four functions related to the ear: the cosmetic appearance, hearing, balance, and facial expression mediated through the facial nerve. Missiles and explosive blast injury can affect all four functions. *Bomb blast explosions will deafen many patients and it will therefore be difficult to communicate with them.*

External ear

Trauma to the external ear is usually quite obvious but unless treated correctly it may well result in considerable deformity.

In simple lacerations, the damaged tissues of the auricle should be carefully excised. The laceration should then be closed primarily in layers, being careful to retain good apposition of the cartilage using absorbable suture material. The skin and subcutaneous tissue should be closed with fine atraumatic sutures.

If the auricle is partially avulsed, careful excision of the dead tissues and re-approximation should be accomplished as soon as possible. In those instances where a portion of the auricle is missing, approximation of the anterior and posterior layers of skin over the exposed cartilage should be accomplished. A haematoma of the pinna should be treated by aspiration or evacuated under strict aseptic precautions and the ear protected with a firm sterile dressing. *The dressing should be removed at least every 48 hours and the wound inspected for recurrence of the haematoma.*

Lacerations of the external auditory canal should be repaired precisely and it is most important to keep the meatus open afterwards, as stenosis is likely to occur. The lumen should be packed with narrow ribbon gauze soaked in antiseptic agent.

Middle ear

Injury to the tympanic membrane is common and is often associated with other more serious injuries. The damage may be caused by:

- direct penetration of the missile;
- fracture of the base of the skull involving the tympanic ring;
- sudden compression of the air in the external auditory meatus as a result of blast.

Blast can damage the hearing in the following ways:

- rupture of the tympanic membrane;
- dislocation of the ossicles;
- damage to the inner ear.

Many of the hearing-damaged patients will have bleeding from the ear. In the absence of a recent history of discharging ear, *the best course is to do nothing*. No attempt should be made to clean up the ear canal because of the risk of contamination. The outer ear should merely be protected with a sterile dressing.

Until the ruptured tympanic membrane has healed, every precaution should be taken to avoid naso-pharyngeal infection. *The patient should be warned not to blow his nose*. If suppuration occurs, it must be vigorously treated with antibiotics. Similarly, in the presence of a leak of cerebrospinal fluid complicating a ruptured tympanic membrane, systemic antibiotics should be used and there should be no attempt to insufflate antibiotic powders into the meatus. This leads to caking, and removal may later cause difficulties.

Inner ear

Trauma to the inner ear may occur in combination with the above injuries or as an isolated injury secondary to penetrating or blunt trauma. Such an injury may be accompanied by total hearing loss, severe vertigo, high-pitched tinnitus or facial nerve palsy.

The most dramatic dizziness occurs after complete destruction of the vestibular apparatus. The clinical picture is that of vomiting,

associated with severe dizziness, even when still, and increasing with the slightest movement of the head. Examination will show horizontal nystagmus. This injury usually occurs after penetrating missile injuries or transverse fractures of the temporal bone.

Labyrinth sedative drugs such as cyclizine are of considerable help and the dizziness tends to improve gradually.

The facial nerve lies in a narrow bony canal and runs a tortuous course through the temporal bone. Immediate damage to the facial nerve in association with a fracture of the skull is likely to be a result of tearing of the nerve or impaction of bone into the nerve. Recovery of nerve function cannot occur without operation, and this cannot be done except by an ear, nose and throat (ENT) surgeon.

NOSE AND PARA-NASAL AIR SINUSES

Nose

Haematoma of the nasal septum

Neglect of a septal haematoma leads to infection, abscess formation, cartilaginous necrosis and nasal deformity. After thorough cleansing of the anterior nares, a free incision should be made, under aseptic conditions, into the anterior and dependent portion of the haematoma, which is then evacuated. A small roll of sterile gauze should then be fixed over the nostrils, being held in place by tapes tied around the back of the head.

Fractures of the nose

Simple fractures

If these fractures are treated within 48 hours, reduction and maintenance of the fragments in position will seldom present much difficulty. Accurate replacement of fragments requires complete disimpaction if it is to be successful. External splintage will be required and this is conveniently made from plaster of Paris (T-shape).

Compound fractures

Thorough cleansing of the wound, excision of any dead tissue and early reduction are essential. Primary closure may be performed after reduction has been accomplished. Badly comminuted

fractures with considerable collapse of the nasal bridge will require full support after reduction. This is best achieved by through and through sutures of nylon or fine wire tied over small lateral lead plates.

Haemorrhage may be so profuse from the nose as to require *intra-nasal packing* with ribbon gauze soaked with sterile saline. This packing should be removed as early as possible in order to bring about reduction.

Packing is contra-indicated in the presence of cerebro-spinal rhinorrhea.

It is important to close wounds around the nose without tension, as for other wounds on the face. Adjoining skin may require undermining to effect apposition without tension. In major skin loss, muco-cutaneous suture will be necessary to obtain soft tissue cover of exposed bone and fractures. *Avoid distortion of the lips and nostrils when doing such closure.*

Maxillary sinus

Simple effusions

Simple effusions of blood into the sinus are usually absorbed and best left alone. If infection occurs, the sinus should be punctured and thoroughly washed out.

Foreign bodies

When the maxillary sinus contains foreign bodies or bone fragments, it should be opened by the sub-labial route, cleaned out thoroughly and counter drainage established into the inferior meatus of the nose.

Depressed fractures

In the case of fracture with depression of the orbital floor and/or anterior wall, it will be necessary to elevate the fragments and retain them in position by means of an antral pack impregnated with penicillin or an appropriate antiseptic.

Frontal sinus

Injuries to the forehead which involve the frontal sinus require operation to restore function and to effect a good cosmetic repair. In severe injuries, a scalp incision which follows the hairline will usually give the best exposure. All loose fragments of bone, debris, foreign bodies and blood clots should be removed from the sinus, which should then be drained into the nose by a plastic or rubber tube surrounded by a split skin graft.

When the posterior wall of the frontal sinus is fractured and the dura mater has been torn, a repair by fascia lata or temporalis graft is necessary.

Ethmoidal labyrinth

When injury occurs to the ethmoid, operation should be avoided if possible for 14 days. There is usually a profuse CSF leak.

In all these injuries, appropriate antibiotic cover, as described in chapter 8, should be given.

PHARYNX

Wounds of the *nasopharynx* and *oropharynx* are often complicated by other penetrating wounds of the neck, head or trunk. The main immediate threat is inhalation of blood. Later, there is a danger of haematoma and infection in the retro-pharyngeal space.

Wounds involving the *laryngopharynx* tend to cause gross contamination of the tissue planes of the neck with saliva or other secretions.

In all cases, careful and wide exposure is necessary to get at the depths of the wound and excise dead and contaminated tissue. Primary repair of the pharynx should be done if practicable, otherwise a planned pharyngostomy should be done with suture of mucosa to skin.

Benzylpenicillin 5 million units 6-hourly should be given.

LARYNX

Blunt injuries to the larynx may commonly cause a laryngeal haematoma, a dislocation or fracture of the laryngeal cartilages, or

soft tissue damage. Such injuries may not cause immediate danger of laryngeal obstruction but that risk is always present. Careful observation is important and this injury may require cricothyroidotomy (see chapter 4) as an emergency procedure.

Compound injuries are more usual in missile injuries, and these wounds have a high immediate mortality unless skilled first aid or medical help is available rapidly. The immediate treatment is to maintain a clear airway and prevent inhalation of blood. Suction is invaluable but with a grossly damaged larynx even an endotracheal tube will not pass and a rapid decision to perform cricothyroidotomy would be life-saving.

Cricothyroidotomy can be life-saving.

Emergency tracheostomy takes too long and is impractical for field use in the circumstances of a war zone. The cartilages of the larynx and trachea are very vulnerable to trauma from artificial tubes. Perichondritis may result, is very difficult to treat and will lead to intractable stenosis.

Once the airway has been secured, the wound should be treated by excision of dead tissue and removal of all foreign material, local drainage and DPC. *The patient should be nursed in the sitting position and encouraged to cough to protect the lungs.* Antibiotics are required as for other soft tissue wounds.

Late reconstruction and repair of laryngeal wounds should be done by an expert.

Fixation of the vocal cords, laryngeal stenosis, damage to the crico-arytenoid joints and paralysis of the vocal cords pose enormous problems. A tracheo-oesophageal fistula should be repaired. If the airway is secured by an adequate cricothyroidotomy, then it might be wise to accept that state and not attempt reconstruction.

17. BURN INJURIES

Burns are a common event in the environment of war. Flame weapons, explosive blast and ignition of combustible materials all create a burns hazard for those involved.

A serious burn injury is a very painful and life-threatening event. The immediate threat is from shock, infection and the complex pathophysiological effects which follow the injury. It is associated with many complications, prolonged morbidity, multiple operations, and great utilization of equipment, materials, medical and nursing time. The long-term sequelae, physical, cosmetic and psychological, play a profound part in morale of both patients and staff. Modern burns centres have made great progress in the successful treatment of major burns, but such facilities are never available in the situations where the ICRC is working. Nevertheless, the principles of treatment are the same, and the aim is to do the best for the patients under these circumstances, tempering enthusiasm with practical reality. Patients with burns covering 40-50 % of the total body surface will rarely survive under field conditions and are best treated by giving fluids to relieve thirst and generous amounts of pain-killers.

Burns are classified by the depth to which thermal damage has occurred.

Burns may be partial or full thickness, and partial thickness burns may be superficial or deep. These categories correspond to the classical three degrees of burns:

- *First degree burns*, or superficial dermal burns, or superficial partial thickness burns. These burns are erythematous, have no blisters and become painful only after several hours.
- *Second degree burns*, or deep dermal burns, or deep partial thickness burns. These burns are usually pink or mottled red in appearance, blisters are common and the surface is moist. They are usually painful and have some sensation to pinprick.
- *Third degree burns*, or full thickness burns. There is destruction of the full thickness of the skin, often with a charred appearance to the wound. They are usually dry and have no sensation to pinprick or touch. They are normally caused by flames, immersion in very hot liquids, electricity or chemical burns.

Although it is difficult to grade the *severity* of burn wounds, the following is a guide :

- Minor:* – second degree less than 15% total body surface (TBS).
 – third degree less than 3% TBS.
- Moderate:* – second degree 15-25% TBS.
 – third degree less than 10% TBS.
- Major:* – second degree more than 25% TBS.
 – third degree more than 10% TBS.

FIRST AID

The patient should be moved away from the source of heat and the flames should be extinguished. Hot or burning clothing must be removed and ideally the patient or the burned part should be wrapped in a clean dressing, sheet of material or blanket. Evacuation to a medical facility should then follow after ensuring a clear airway. Pain-killers should be given, if available.

HOSPITAL CARE AND RESUSCITATION

The extent and depth of the wound should be assessed. *Resuscitation regimes are based upon the amount of partial and full thickness injury as well as the weight of the patient.*

Assessment of the total body surface (TBS) burned area is essential in order to estimate the patient's requirements for replacement of fluid loss.

FIGURE 1

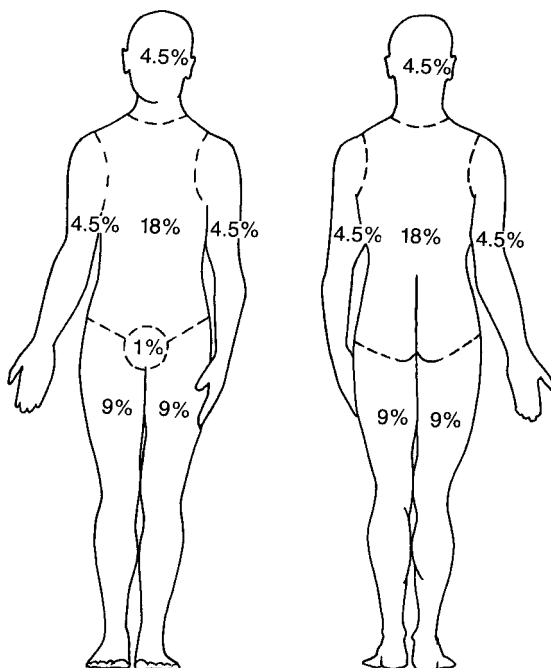

The "Rule of Nines" to assess total body surface burned area in an adult.

The simple calculation is best done using the "Rule of Nines" (Figure 1):

- Each upper extremity 9%
- Each lower extremity 18%
- The front of the trunk 18%
- The back of the trunk 18%
- The head 9%
- The perineum 1%

The size of the patient's hand is about 1% of TBS.

The head and neck of a child under one year old represent 21% and the lower extremity 14% of TBS (Figure 2). These figures change to the adult levels with progressively older children.

FIGURE 2

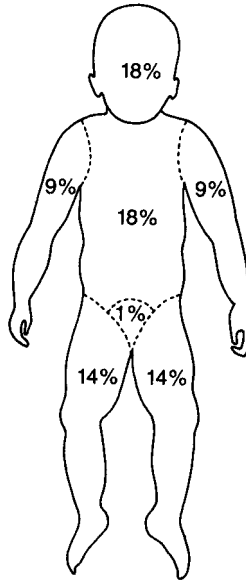

Assessment of total body surface burned area in a child.

The patient should be weighed as soon as possible after injury.

Patients with fresh injuries of moderate and major severity should get a naso-gastric tube to keep the stomach empty, to prevent acute dilatation and aspiration of stomach contents, leading to pneumonia.

A Foley catheter should be placed in the bladder because the measurement of urine volume every hour is of vital importance in monitoring the adequacy of resuscitation.

Initial replacement therapy

The most important pathophysiological change as a result of thermal injury is widespread increase in capillary permeability.

Plasma water and numerous plasma proteins up to a molecular weight of 350,000 are freely exchanged between the intra and extra-vascular compartments of the extracellular space.

The loss from the vascular compartment in large burns occurs at an approximate rate of 4 ml/kg/hour.

This loss is most marked in the region of the burn wound and accounts for the local oedema, but it also takes place elsewhere in the body causing generalized oedema. There is an associated rapid rise in the haematocrit which, together with polymerization of some plasma proteins, causes a marked increase in blood viscosity.

With adequate initial resuscitation with crystalloids, the capillary integrity can be mostly restored by 18-24 hours after the burn. At this point, colloid can be given and will stay within the vascular compartment, increasing the plasma volume. Cardiac output will respond to fluid replacement long before blood and plasma volumes return to normal. Red cell life is reduced and although replacement of red cell mass is not necessary for the first 48 hours, it will probably be necessary after this time.

The fluid used for resuscitation varies with different techniques, but basically it is either crystalloid or colloid. Experimental and clinical evidence show that either may be used with success, provided that treatment is started quickly and clinical response to adequate volume replacement is closely monitored.

There are three phases of resuscitation therapy:

- the first 24 hours from infliction of the burn wound;
- the second 24 hours;
- after 48 hours.

The first 24 hours

Use Ringer's lactate solution 4 ml/kg/% burn.

- First eight hours: 2 ml/kg/%.
- Second eight hours: 1 ml/kg/%.
- Third eight hours: 1 ml/kg/%.

Measure the urine output and aim to keep it between 30-50 ml/hr for adults and 20-30 ml/hr for children.

If the output goes above these levels, reduce the rate of infusion to avoid pulmonary oedema. If the urinary output is low and does not respond to increased infusion in the second eight hour period, then replace the third eight hour period Ringer's lactate with colloid, plasma or 5% albumin if available.

Keep a close watch on clinical vital signs, particularly the peripheral circulation, the patient's general condition, such as conscious awareness, restlessness, nausea or vomiting, and on the haematocrit.

The second 24 hours

During this phase, expansion of plasma volume can be achieved.
Give plasma 0.3 to 0.5 ml/kg/%/day.

Maintenance of normal electrolyte requirements should be started on the basis of:

- Water 2,000 ml/m²
- Na 50 mE/m²
- Cl 40 mE/m²
- K 40 mE/m²

Evaporative water loss through the burn wound becomes apparent at this stage and should be replaced, in addition, by electrolyte-free water, such as 5% Dextrose in water, at a rate of 2 ml/kg/%/day.

After 48 hours

Mobilization of burn wound oedema takes place with diuresis, high cardiac output, tachycardia and anaemia. All these are related to the expansion of blood volume by mobilization of the oedema fluid.

After 48 hours, there are normal water and electrolyte requirements, plus replacement of evaporative water loss at 1-2 ml/kg/%/day of 5% Dextrose in water.

If available, plasma or albumin should be given to maintain serum albumin of 3 g/100 ml and blood to maintain a haematocrit between 35-40%.

Potassium is generally excreted in large amounts at this time, 80-160 mE/day may be required.

Magnesium can be supplied as magnesium sulphate, 1-3 g/day.

Calorie requirements:

Adults 25 Kcals/kg plus 40 Kcals/%/day

Children 65-80 Kcals/kg plus 40 Kcals/%/day

Protein requirements to match the calorie needs are 3-5 g/kg + 1 g/%/day.

Monitoring resuscitation

Clinical evaluation of the response to effective correction of the hypovolaemic state is vital.

Clinical evaluation is particularly important in the absence of sophisticated means and laboratory measures. A clear sensorium, good tissue perfusion, good pulse, and an adequate urinary output are all signs of good progress.

CARE OF THE BURN WOUND

Following successful resuscitation of the patient, the burn wound and the complications of burn sepsis present the greatest threat to life.

The aim of treatment is to achieve healing of the burn by the following measures:

- control of bacterial colonization by removal of all dead tissue as soon as possible;
- prevention of accumulation of purulent fluid and debris;
- prevention of secondary bacterial contamination;
- maintenance of an environment which promotes wound healing;
- avoidance of techniques or treatment which will damage the healing burn wound.

Most of the morbidity and mortality associated with major burns are the result of infection. All the methods of cleaning the wound, excising dead tissue and treatment of the burn are directed towards the control of “burn wound sepsis”.

Third degree burns are basically ischaemic, with confluent thrombosis of all local blood vessels. In partial thickness burns, necrosis and thrombosis are incomplete; viable areas of dermis underlie the necrotic tissue and will gradually re-establish themselves if given the opportunity. Because of the complete or partial ischaemia associated with burn wounds, systemic antibiotics may not reach the site of bacterial colonization. Local care with local treatment, both mechanical and antimicrobial, is extremely important.

Initial wound management

When the burn wound has been assessed and resuscitation has started, *attention can be turned to cleaning the wound.*

The patient should be sedated and the burn wound washed with detergent soap or povidone iodine scrub solution if available. Blisters should be left undisturbed but broken blisters and non-viable tissue should be removed. Large burn wounds may be more easily cleaned by placing the patient in a bath or shower.

During the first 48 hours, the increasing oedema of the tissues and the constricting effects of the thick unyielding burn eschar may result in a tourniquet effect when the burns are circumferential. Burns of the chest may restrict breathing and those of the limbs may cause ischaemia.

Escharotomy is the process of incising the eschar down to the subcutaneous fat to allow relief of the constriction.

Escharotomy should be performed with a sharp knife without anaesthetic, because such full thickness burn areas are insensitive.

Local care

The methods of primary burn wound care depend on the depth, extent and location of the burn. They include: exposure treatment; occlusive dressings; wet dressings; open therapy with topical antibacterial agents; and the plastic bag method.

Exposure treatment

This method is used to control bacterial colonization without the aid of topical agents by utilizing a warm dry environment. It is particularly suitable for burns involving the face, perineum and for unilateral trunk or limb burns. The patient is placed on a clean dry sterile surface and the burned area is completely exposed. The ambient temperature needs to be 35-40°C in order to prevent the patient shivering, and the air should be dry.

Eschar formation is usually complete by 24-36 hours, and constitutes a protective cover against bacterial contamination.

The eschar must be inspected each day for any signs of cracking of the surface or infection. If full thickness burns are exposed, the eschar will become hard and like leather. Eventually it will start cracking and infection will occur. At this point, the treatment will need to be changed or escharectomy and grafting will have to be performed.

Occlusive dressings

Bulky sterile dressings protect the burn wound from infection, absorb serum and exudate, keep the injured part immobile, and are comfortable for the patient.

The dressings have two components, an inner dressing which applies an antibacterial agent to the burn, and an outer dressing which absorbs the exudate and protects the wound.

The antibacterial agent, silver sulphadiazine (Flamazine) should be applied liberally to fine-mesh gauze. The agent may be used under occlusive dressings without fear of toxicity. The outer dress-

ing should be made from large gauze pads, held in place with bandages or adhesive tape. If the dressing becomes soaked through, the outer layers should be changed or bacterial contamination will occur. Dressings are normally left in place for 3-5 days, if all is well.

Wet dressings

These are dressings soaked in saline or 0.5% silver nitrate solution, which are applied to the burn eschar and left in place. The dressings are soaked every two hours or so to keep them wet, and they are changed once or twice a day. This method is impractical for field conditions.

Open therapy with topical antibacterial agents

For extensive burns this is the method of choice.

The advantage of this method of treatment is that it allows easy examination of the burn wound so that infection may be recognized and treated early. It also allows early mobilization by physiotherapy, hyperthermia is avoided, and it is easier for nursing purposes.

The disadvantages are delayed eschar separation and significant pain from some of the topical agents. Hypothermia has to be prevented by a warm atmosphere, and frequent soaks in a bath or shower are needed to wash away exudate and fragments of softened eschar.

Silver sulphadiazine 1% in a water-soluble cream base (Flamazine) is the most practical agent to use. The ointment should be applied to the burn wound liberally with a sterile gloved hand, or to a length of gauze which is saturated with the antibacterial agent and then applied to the burn and smoothed into place. This will need to be repeated twice daily or as required.

The plastic bag method

This method is used for burns to hands and feet. After cleaning, any plastic bag can be used as a glove or a sock, tied around the wrist or ankle. It must not be too tight, so as to allow for swelling. The burned area will be kept moist and movement of the joints, both passive and active, is encouraged.

EXCISION OF ESCHAR AND SKIN GRAFTING

The preparation of the burn wound and its subsequent closure are the two main steps in the management of burns. The type of surgery required depends upon the skill and training of the surgeon, the burn injury and the facilities available to support the treatment. Like all other injuries treated under difficult circumstances, great judgement is required to select the technical procedure which is both possible and practicable.

Removal of dead tissue

The dead tissue or eschar produced by thermal injury may be removed completely in a single procedure or in a number of stages. The aim of treatment is to prepare the wound for eventual closure and to prevent colonization by bacteria and fungi.

Mechanical methods

Thorough cleaning and removal of debris and fragments of eschar, as described above, should be done at each dressing session. Gentle scraping or picking away the fragments should be combined with thorough irrigation with water or in a bath. The surface can then be cleansed with a detergent solution (half a cup of detergent powder, one litre of 0.9% saline, 500 ml of 3% hydrogen peroxide) and thoroughly washed again with water.

Excision

The removal of the full thickness of the burn wound has to be done at some time in order to prepare the site for eventual skin cover.

Early excision of full thickness burns and immediate auto-graft has enormous benefits, but is impracticable for areas greater than 10% TBS, outside specialized burns centres.

The emphasis for most field surgeons should be on conservatism in relation to this technique.

Tangential excision is the process whereby the superficial layers of the burned tissue are progressively shaved away. This can be done by knife, dermatome or cutting diathermy. The process

should be continued until pinpoint bleeding is obtained. When successful, only dead tissue is removed. It is difficult to judge how much to take away in order to leave a viable layer that will take a skin graft. The technique is, however, recommended for small burned areas, for hands and over joint surfaces.

Big excisions can only be done if blood is available; even so, it is advisable not to excise more than 10% of TBS.

Skin grafting

The purpose and techniques of obtaining skin cover are as detailed in chapter 7.

The face, hands, feet and joint surfaces are included in the priority areas in order to re-establish function.

Old wounds or sites where previous grafts have failed are notorious for the difficulty in getting an adequate graft take. Meticulous preparation of the surface is the way to success.

The occlusive dressing which is applied after skin grafting has a great part to play in the survival of the graft. It must be put on with great care, because it is vital for the dressing to hold the graft closely applied to the grafted site for the first few days so that capillaries can grow. Any blood, serum or foreign body that floats the graft away from its bed will cause it to fail.

The life of a patient with a severe burn is in danger until the dead tissue has been excised and the defect closed with a healthy skin graft.

PHOSPHORUS BURNS

Many anti-personnel weapons used in warfare contain white phosphorus. *This element ignites on contact with air*, and fragments of phosphorus will be scattered throughout any wounds caused by such weapons. Most of the injury results from the ignition of clothing, which causes a conventional burn. It is a real problem to deal with a wound in which the embedded particles of phosphorus will ignite as soon as the tissue dries out. Medical teams as well as patients are in danger.

Phosphorus burn wounds must be kept wet by soaking them liberally with water and covering them with wet dressings. On no account must they be allowed to dry out.

When surgical treatment is available, the wet wound can be irrigated with a freshly prepared solution of 1% copper sulphate. *This is a very dilute solution*; check that it is of palest blue colour. This solution combines with phosphorus to form black copper sulphide, which impedes violent oxidation and identifies the particles. The black particles can then be removed with forceps and placed in a dish filled with water. After completing the procedure, the copper sulphate solution must be washed away, and the wound excised and dressed in the way described above.

NAPALM INJURIES

Napalm is an intensely flammable agent in a liquid form, which will cling to the injured patient and cause serious and extensive burns.

Napalm burns *are invariably full thickness, with coagulation of muscles and other deep tissues*. Nephrotoxicity is a serious complication, and the mortality may be high in proportion to total body surface area involved. A full thickness burn of only 10% of the body surface area may result in renal failure.

18. COLD INJURIES

The significance of prevention and treatment of cold injuries as a military medical problem cannot be overemphasized. Although most commonly seen in arctic and subarctic climates, cold injuries can occur whenever the combination of cold, wet, wind and immobility exist.

PHYSIOLOGY OF THERMAL REGULATION

Normal body temperature is maintained through a balance between heat production and heat loss, and is regulated by a hypothalamic “thermostat”. At least 95% of the heat produced by metabolism is normally lost to the environment by conduction, convection, radiation and evaporation.

The skin primarily acts to dissipate heat by regulating its blood flow which may vary from 50 ml/min to 7000 ml/min. The lungs are also a significant source of heat loss.

In a cold environment, the *core temperature* (that is, the temperature of the vitally important visceral organs) is conserved by decreasing heat loss by peripheral vasoconstriction, and by increasing the production of heat by involuntary muscle contractions (*shivering*). If the heat loss exceeds the heat producing resources of the body, the core temperature begins to fall and *hypothermia* develops.

In peripheral tissues subjected to low temperatures, local cold injury may result from vasomotor and/or cellular effects.

LOCAL COLD INJURIES

Local cold injuries can occur at temperatures above or below freezing point and are classified as non-freezing injuries or freezing injuries.

Non-freezing injury

This type of cold injury, also known as “immersion foot” or “trench foot”, is seen in prolonged exposure to cold ambient temperatures above freezing, with high humidity and immobilization. Such injuries are diagnosed and treated like other cold injuries.

Freezing injury

This type of injury, also known as frost-bite, may be:

- superficial, in which only skin and subcutaneous fat are involved;
- deep, where structures such as muscle are involved.

It is not easy to differentiate, in the early stages of injury, between superficial and deep wounds.

Symptoms and signs

These include:

- paresthesia (numbness);
- pallor (wax-white or mottled blue discoloration);
- paralysis (impaired movement);
- hardness;
- swelling (particularly in non-freezing injuries).

First aid and transport

Place the patient in a shelter as soon as possible. Remove boots and socks, avoiding trauma to the skin.

As some degree of hypothermia generally co-exists with local cold injury, the general body temperature should be raised by hot drinks, etc. Further loss of heat should be prevented by blankets or skin-to-skin contact. When a local cold injury co-exists with hypothermia, the frozen extremity should be gently packed in ice and prevented from thawing before normal core temperature is reached.

Provided there is no hypothermia, immediate thawing of the local cold injury should be commenced. Any available form of heat transfer, such as skin-to-skin contact, foot in axilla and hand to nose contact, should be utilized. Rapid rewarming in warm water (40-42° C, or just tolerable to elbow immersion) should only be used when refreezing can be avoided. A part frozen solid for hours, or walking on frozen feet, carries less risk of tissue loss than the cycle of thawing, refreezing, and thawing.

Analgesia is essential, as thawing of frost-bite is painful.

Do not:

- rub or massage injured tissue;
- apply ointments or other topical medication;
- break blisters,
- rewarm by dry or radiant heat (danger of fire).

Treatment

If the limbs are still frozen or cold and vasoconstricted on arrival at a medical facility, they should be rapidly rewarmed in 40-42° C water. Even if only one limb is affected, both should be rewarmed. If the patient is not hypothermic, a dose of warm alcoholic drink may be given to alleviate the pain and to produce vasodilatation in the affected area. *Aspirin* still appears to be a most useful drug in pain relief and possibly in preventing tissue loss.

Heparin, anticoagulants, corticosteroids, antihistamines and intravenous dextran have all been shown to be of little benefit. Disagreement exists on the effect of sympathectomy.

After care. Once rewarming is complete, little more can be done to alter the course of events.

The basic treatment is conservative wound care.

The extremities should be kept on sterile sheets under cradles. Sterile cotton pledgets are placed between toes or fingers. Warm hibitane soaks twice daily help prevent superficial infection. As blebs appear, precautions are taken to avoid their rupture. A good

functional result will be helped by maintaining active exercises and elevating the affected limb.

It is difficult to predict the extent of eventual tissue loss from frost-bite during the first weeks after injury. Tissue loss, however, is generally smaller than expected. It is therefore important to wait until the damaged tissue becomes necrotic and mummified, with demarcation and spontaneous amputation of fingers or toes.

The treatment of local cold injury is to avoid surgical removal of tissues unless secondary infection intervenes. The natural process is allowed to happen.
“Frozen in January, amputation in July”.

19. RECONSTRUCTIVE SURGERY

War wounds, like other major trauma, will often require major reconstructive surgery to obtain a reasonable functional result. Lack of adequate facilities, experienced operators and time will often limit the extent to which reconstructive surgery can be performed. Moreover, *many reconstructive procedures require several operations spaced over many months to be completed. It is pointless to start a protracted set of procedures if the operator's length of mission is three months.* Those following may be unable to complete the procedure satisfactorily. For this reason, a conservative approach may, in the long term, be the preferred course.

Despite these considerations, there will be many occasions when appropriate reconstructive surgery is indicated and can be performed effectively.

SOFT TISSUE DEFECTS

A significant degree of tissue loss will often prohibit simple approximation of wound edges. Or wound edge approximation might be possible but large areas of dead space beneath make direct wound edge suture inappropriate. In wounds where there has been major tissue loss, *skin grafts* (chapter 7) or *flaps* will be required to close the defect. When avascular areas, such as exposed bone without periosteum or tendon without peritenon, need coverage, or when vital structures are exposed, a flap will be necessary for wound closure.

Flaps may be simple or complex (composite), local or distant. Most flaps have a random blood supply, that is, their blood supply is derived only through the subdermal plexus of vessels and not

through any specific named artery. For this reason, these flaps must maintain a base which is equal to the length of the flap, to ensure that all of the flap will survive. This 1:1 ratio can be broken only in places where the blood supply to the skin is very generous, such as on the scalp or face.

Local flaps

Local flaps with random blood supplies are used when tissue adjacent to or very near a wound is used for skin closure. There are four main types of local flaps:

- *Advancement flaps.* These are performed by undermining the edge of a wound, incising the tissue for a distance along the lines of greatest tension, and advancing the tissue to cover the defect.
- *Rotation flaps.* These are designed along an arc which is incised adjacent to the wound. This arc is undermined and the tissue is rotated to cover the defect.
- *Transposition flaps.* These are used when tissue adjacent to the wound is used to close the defect. The edge of the wound makes up one side of the flap, while the other two edges are created by incising a rectangular-shaped flap of adjacent skin. A skin graft is required to close the defect.
- *Interpolation flaps.* These use tissue not directly adjacent to the defect, which means that the pedicle has to cross over normal tissue to reach the defect.

Arterialized flaps

Arterialized flaps have a central vascula bundle which supplies blood flow to the skin of the flap. *Examples of these are:*

- the groin flap supplied by the circumflex iliac artery and vein;
- the deltopectoral flap based on the perforating branches of the internal mammary artery;
- the forehead flap based on the superficial temporal vessels.

Musculo-cutaneous flaps

Musculo-cutaneous flaps are composed of muscles and their overlying skin, blood supply to the skin being supplied by perfo-

rating musculo-cutaneous vessels. The commonly used musculo-cutaneous flaps include the tensor fascia lata and either medial or lateral heads of the gastrocnemius muscles in the lower extremities, latissimus dorsi, sternomastoid or pectoralis major flaps in the upper body.

BONE PROBLEMS

Nearly all bone wounds seen will be compound injuries, some of many days or weeks duration. As a result, complications of bone union are common.

The three major problems encountered are malunion, non-union and osteomyelitis.

Malunion

Some fractures will be quite old at the time of presentation, with fairly well-established malunion having occurred. In these situations, a decision must be taken on whether to accept the degree of malunion present, especially considering the risks involved with attempted correction. In some cases, malunion will be such that reasonable function is not possible and reconstructive surgery is advisable. The decision must be made by the surgeon and the patient in each case.

Non-union

Non-union of fractures is common. It may be the result of soft tissue interposition between fracture ends. Fresh cases should be explored and the interpositioned tissue removed. If there is no radiological evidence of union *after three months*, the fracture site should be inspected and freshened and a bone graft inserted. If there is less than 50% union after six months, the same procedure should be adopted.

Osteomyelitis

Bone infection complicating fractures is a common problem. Basic principles apply, especially concerning the use of antibiotics. *Antibiotics are of no value when sequestra are present.*

Treatment

Exploration:

- non-union: in fresh cases where it is impossible to get proper alignment of fracture ends, the area must be (re)explored to remove soft tissue stuck between the bone ends.
- osteomyelitis: surgical excision, including curettage (small draining sinus), sequestrectomy and fenestration.

In any situation where there is a persistent discharging sinus, surgical excision of necrotic tissue, including bone, is required before healing will occur.

Bone grafting is used in:

- the correction of malunion;
- cases of non-union;
- order to fill gaps between fractures, where sequestra have been removed.

The donor site will generally be the ilium and cancellous bone will generally be used. Cortical grafts and bicortical grafts consisting mainly of cancellous bone can also be taken from the ilium but will only be required when more complicated surgery, such as mandibular reconstruction, is involved. The ilium is used because a generous amount of cancellous bone can be harvested and it is easily accessible.

The same basic technical standards that apply to skin grafting apply to free bone grafting. *Cancellous bone should not be placed in an infected site and should not be placed in haematoma.* Bone ends of the recipient area should be freshened. Provided the recipient site is clean and dry, the transfer of cancellous bone is the ideal method of transferring bone from a donor to a recipient site.

To stabilize the grafted area, external fixation is usually needed.

Good bone union following bone grafting will occur at the same rate as uncomplicated fracture union.

SKIN CONTRACTURES

Secondary surgery to improve function following burns is always indicated. Most of these scars will be over flexures where, because of shortage of skin, addition of skin will be required.

These contractures will not improve with the passage of time or by splinting alone. Scars over extensor surfaces will seldom lead to loss of function, with the possible exception of the back of the hand. In this case, treatment is wide excision and grafting.

The two methods of correcting flexure contractures are Z-plasty and skin grafting.

Z-plasty (Figure 1) can be used when skin on each side of the scar is normal and the scar is not very wide. Where Z-plasty can be used satisfactorily, a 30-35% gain in length is achieved. Often, multiple Z-plasties in the length of the wound will be required, rather than a single incision. The scar should be excised and the angle of the tip of the flap should be as close to 60° as possible, otherwise there will be little gain in length. *Z-plasties should never be performed on contracted skin grafts, because the flaps will always become necrotic.*

FIGURE 1

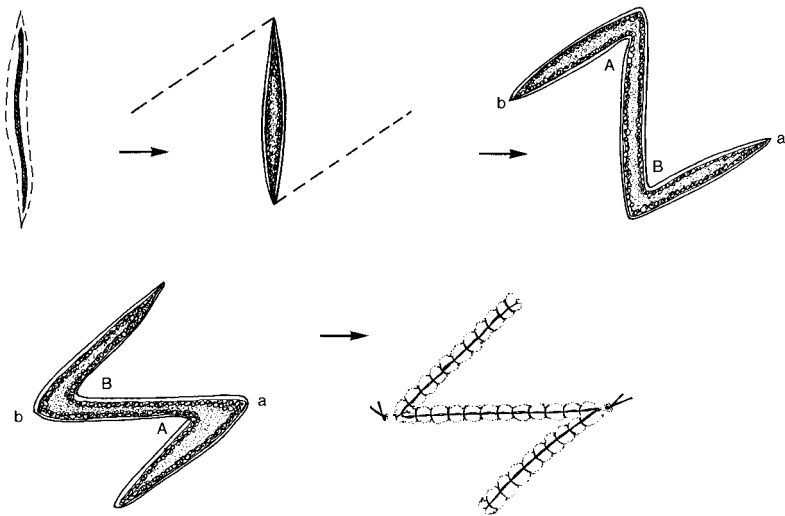

Z-plasties.

When the contracture scar covers a wide area, Z-plasty will be ineffective. The treatment of choice will be *either a cross cut and graft or a diamond-shaped excision of the scar and graft*.

When performing a cross cut, the scar is cut across at the level of the deep fascia, extending laterally into normal skin. A thick split skin graft is to be inserted into the defect and an extension splint applied to the limb for as long as six weeks afterwards.

Where a cross cut cannot be performed because of a particularly lumpy or ulcerated scar, the scar should be excised as a diamond, not as a circle, and a thick split skin graft applied. Again, splinting of the limb in extension for up to six weeks afterwards will be necessary. Caution must be exercised when splinting limbs in older people because of possible fibrosis of the joint capsule, resulting in stiff joints. This is seldom a consideration in children.

PERIPHERAL NERVE INJURY

There is no place in war injuries for primary repair.

Assessment of peripheral nerve function should be performed as best possible prior to the initial exploration of a wound. However, missile injuries with considerable amounts of devitalized tissue and the surgical procedure of wound excision might not allow accurate assessment of the extent of nerve injury for at least 15-20 days. Surgical repair of the peripheral nerve can be planned as soon as all evidence of infection has subsided.

If nerve function is impaired, the appropriate nerve or nerves should be inspected at the time of the first operation and the degree of damage recorded. If there has been complete division of the nerve, the ends should be identified and tacked down to separate areas of soft tissue to maintain proper stump length for eventual repair. If the nerve has been contused it is reasonable to wait for up to three months before re-inspection.

It is important to assess any peripheral nerve damage resulting in significant functional impairment, such as foot or wrist drop, even months after injury. On occasions, neurolysis, excision of a neuroma and nerve repair can eventually result in restored function.

Delayed repair of a severed nerve should be done at 3 to 6 weeks by mobilizing the nerve freely to allow accurate anastomosis. Large defects should be bridged by composite grafts made of several lengths of a cutaneous nerve.

TENDON REPAIR

Primary repair should not be attempted.

Much the same basic principles apply with tendon injuries as with peripheral nerve injuries. Damage should be assessed and recorded at the time of surgical excision, and repair performed once all evidence of infection has disappeared, and primary healing of the wound has occurred.

VASCULAR COMPLICATIONS

Arterio-venous fistulas (Figure 2)

Arterio-venous (A-V) fistulas can be largely avoided if penetrating wounds are adequately explored, especially those near large vessels, such as the axilla and groin. An injured major vein should be repaired, if possible, especially when there is associated arterial injury. Small isolated venous injuries are not critical and may be ligated.

If an A-V fistula is encountered, it should be repaired. This is done by adequate exposure of the area to allow for proximal and distal vascular control. Small fistulas can just be divided and the holes in the artery and vein oversown. Bigger fistulas should be excised, and the artery and vein repaired as the damage requires. If primary anastomosis is to be effected, it must be without tension. About 4 cm of a vessel must be mobilized for each centimetre of resected vessel to prevent tension. If primary anastomosis cannot be accomplished, a saphenous vein graft, generally harvested from the opposite extremity, will need to be inserted.

FIGURE 2

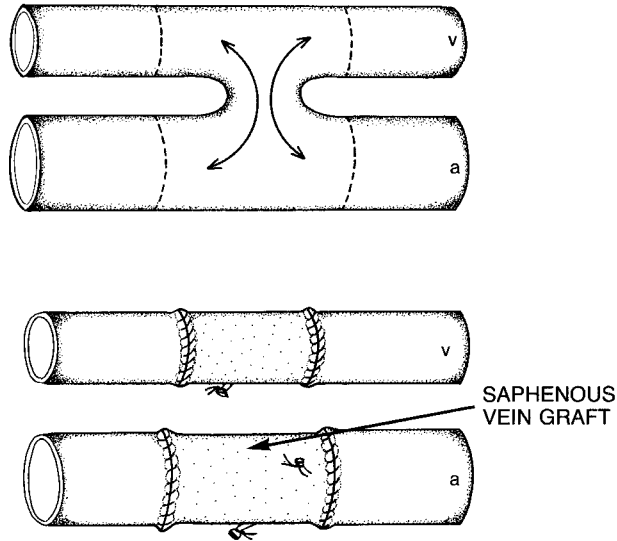

Repair of arterio-venous fistulas.

Pseudoaneurysms

An arterial injury will result in bleeding and haematoma formation. Sometimes the haematoma will be transformed into an aneurysm and the patient will present with a pulsating mass. Vascular control above and below the aneurysm must be secured. After clamping, the aneurysm is opened and the hole identified. If the hole is small and the wall of the vessel is healthy, simple suture of the hole can be done. If there is a big hole and the wall is soft, a resection with an interposition of a venous graft must be performed.

These operations should not be attempted unless the surgeon is experienced in vascular surgery. Failure could make matters worse and threaten the viability of the limb.

20. ANAESTHESIA IN WAR SURGERY

The standard anaesthetic practices, as utilized in trauma care, should be followed. The points listed below are particularly important in the context of war surgery.

PREOPERATIVE PREPARATIONS

- The presence of a good interpreter is essential.
- Assessing the time the patient last ate is difficult, especially with breast-fed babies.
- Many wounded, especially in hot climates, will be severely dehydrated. Correct hypovolaemia before surgery, if time allows.
- Unfamiliarity with anaesthetic equipment and local conditions increases the likelihood of complications. Make certain that an assistant, if available, is at hand.
- Routine premedication will not be necessary. Atropine, if indicated, can be given intravenously in the operating theatre.
- Arrangements for blood may require local collecting facilities to be activated. Order likely blood requirements early.

ANAESTHESIA METHODS

Oxygen, nitrous oxide and volatile anaesthetics may be in short supply. Consider the possibility of using local and regional anaesthesia, and ketamine. Oxygen concentrators are very useful.

The following are the anaesthetic agents of choice.

Surface anaesthesia

Ophthalmic: 0.4% oxybuprocaine or, if not available, 0.25-0.5% cocaine or 0.5% proxymetacaine.

Mucosa: lignocaine jelly.

Infiltration anaesthesia

Lignocaine 1% with adrenaline. If a volume greater than 30 ml is required, the lignocaine can be diluted with an equal volume of isotonic saline.

Nerve block

Digital: lignocaine 2% *without* adrenaline.

Axillary: lignocaine 1.5% *with* adrenaline.

Regional intravenous anaesthesia

Prilocaine (Citanest) 0.5% without adrenaline.

Regional anaesthesia

Spinal subarachnoid block with hyperbaric lignocaine 1.5-2.0 ml or 0.5% bupivacaine 2.5-4.0 ml.

Spinal puncture is performed with a thin 25 gauge needle with the patients on their unaffected side. The classical sites are:

- L 3-4 for lower limbs;
- L 2-3 for hip and pelvis.

If bradycardia develops: atropine 0.5-1.0 ml can be given.

Ketamine

This is very safe, especially for children.

Dosage: Intramuscular 10 mg/kg body weight.

Intravenous bolus 2 mg/kg body weight.

These doses give analgesia for 10-20 minutes. For longer procedures, an intravenous infusion can be added at a dose of 2-6 mg/hour/kg body weight, the rate being titrated against the response.

Hallucinatory side effects do occur with ketamine, especially in adults, and once encountered are likely to be repeated on other occasions in the same patient. The incidence and severity of hallucinations can be lessened by using diazepam 10-15 mg intravenously before induction.

Ketamine must be combined with muscle relaxants if used for abdominal surgery.

General anaesthesia

Induction

- Analgesia with fentanyl 0.1 mg, pethidine 50 mg, or morphine 5 mg.
- Atropine 0.5-1.0 mg if indicated.
- Thiopentone 2.5% solution, titrated against response.
- Ketamine is available for induction. It is indicated especially if the patient is shocked because it does not cause hypotension as thiopentone does.
- Succinylcholine 1 mg/kg body weight facilitates rapid tracheal intubation.

Cricoid oesophageal compression should always be utilized until the endotracheal tubecuff is inflated.

Maintenance

- Pancuronium 0.1 mg/kg.
- Halothane, and occasionally other inhalational supplements such as enflurane and isoflurane may be available.
- Oxygen concentrators are often available.
- Oxygen cylinders must be checked to see that they are full and that connections fit the system used.

Recovery

- Reversal with atropine 1 mg and neostigmine 1.5-2 mg.
- As there will seldom be a designated recovery room, the patient should be awake and stable before leaving the operating theatre.
- Intravenous lines, drains and catheters should be closely checked before transfer.

DOSAGE GUIDE

<i>Indication</i>	<i>Drug</i>	<i>Recommended volume</i>	<i>Comments</i>
Infiltration	Lignocaine +/- adrenaline 0.5-1%	up to 50 ml	Do not use adrenaline for penis, digits or ears.
Brachial plexus block	Lignocaine with adrenaline 1-1.5% or bupivacaine 0.5% with adrenaline	15-35 ml	Where early movement is desired. Provides prolonged sensory analgesia.
Peripheral blocks	Lignocaine or bupivacaine without adrenaline 0.5-1%	5-20 ml	Bupivacaine should be used where prolonged anaesthesia is required.

FURTHER READING

- Coupland, R.M. (1991) *The Red Cross wound classification*, International Committee of the Red Cross, Geneva.
- Coupland, R.M. (1992) *Amputation for war wounds*, International Committee of the Red Cross, Geneva.
- Coupland, R.M. (1993) *War wounds of limbs: surgical management*, Butterworth Heinemann, Oxford.
- Gray, R. (1994) *War wounds: basic surgical management*, International Committee of the Red Cross, Geneva.
- Hayward-Karlsson, J., Jefferey, S., Kerr, A., Schmidt, H. *Hospitals for war wounded*, International Committee of the Red Cross, Geneva, 1998.
- King, M. (ed.) (1994) *Primary anaesthesia*, Oxford University Press, Oxford.
- King, M. and Bewes, P. (eds) (1993) *Primary surgery - Volume 2: Trauma*, Oxford University Press, Oxford.
- Rowley, D.I. (1996) *War wounds with fractures: a guide to surgical management*, International Committee of the Red Cross, Geneva.
- Sellier, K.G. and Kneubuehl, B.P. (1994) *Wound ballistics and the scientific background*, Elsevier, Amsterdam.

Mission

The International Committee of the Red Cross (ICRC) is an impartial, neutral and independent organization whose exclusively humanitarian mission is to protect the lives and dignity of the victims of war and internal violence and to provide them with assistance. It directs and coordinates the international relief activities conducted by the Movement in situations of conflict. It also endeavours to prevent suffering by promoting and strengthening humanitarian law and universal humanitarian principles. Established in 1863, the ICRC is at the origin of the International Red Cross and Red Crescent Movement.

SURGERY FOR VICTIMS OF WAR

Much has been written about the theory and principles of war surgery as practised by military medical units. This book, which summarizes the practical experience of eminent specialists from different parts of the world, aims to provide a broad introduction to the subject for members of surgical teams, whether military or civilian, who may be faced with the treatment of wounded in situations or armed conflict - situations which demand a quite different approach from that normally found in civilian practice.

Among the subjects covered are: first aid, triage and reception of casualties, skin grafts, infection, treatment of neglected and mismanaged wounds, the treatment of wounds to different parts of the body, burns, reconstructive surgery and anaesthesia.

One of the chief characteristics of warfare is that sophisticated weapons cause highly damaging wounds, for the most part contaminated, in a context in which the medical infrastructure is poor. Field hospitals, such as those set up by the Red Cross in conflict zones, have to serve both as hospitals of first contact and as referral units, combining primary, secondary and basic reconstructive surgery. As the authors of this book point out, these circumstances require surgeons to have an all-round approach and to be able to use very simple means of treatment, often improvising to achieve maximum care under difficult conditions.

The International Committee of the Red Cross (ICRC), founded in 1864 with the express purpose of improving medical care for the wounded in wartime, has published this book in the hope that its own experience in this field - and that of the book's authors - will help give victims of warfare the best possible chance of survival and recovery.



ICRC